

OXBERRY®

MODEL 5332-00

*Filmmaker 16mm
Animation Stand
and Camera*

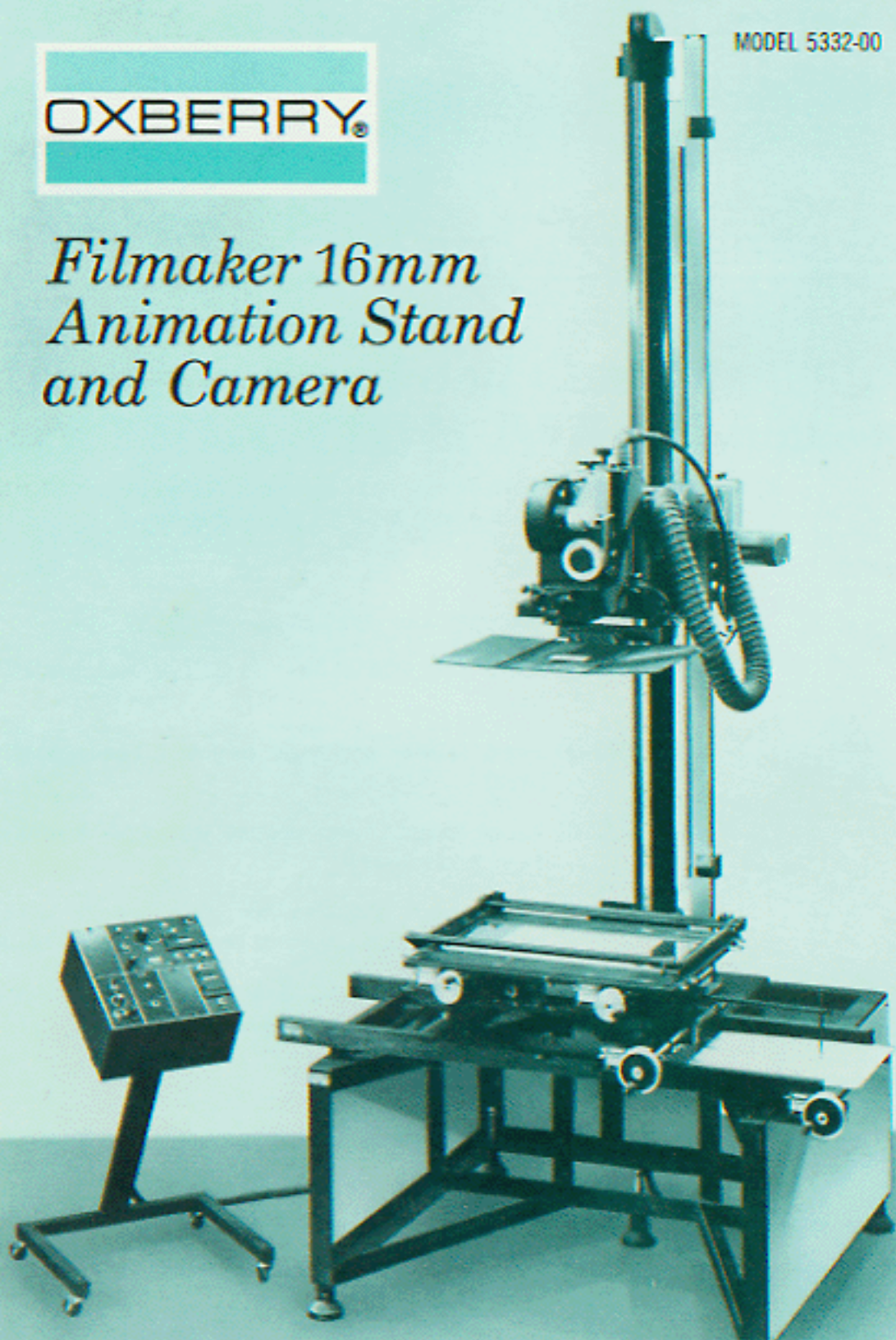

INSTRUCTION MANUAL

BERKEY TECHNICAL

25-15 50TH STREET, WOODSIDE, N. Y. 11377

SALES AND SERVICE OFFICES

CALIFORNIA: 1015 CHESTNUT STREET, BURBANK
CANADA: 3020 ELMBANK RD., MALTON, ONTARIO
ENGLAND: BURRELL WAY, THETFORD, NORFOLK

A DIVISION OF
Berkey
Photo Inc.



OXBERRY PRODUCTS

Optical Printer Series

5117 Special Effects Step Printer with automatic focus, automatic dissolve and fade, multi-speed drive for 35mm and 16mm.

5 Models available:

Model 5117-00 Main projector head (single head)

Model 5117-20 Aerial image and main projector head (double head)

Model 5117-30 Beam splitter and main projector head (double head)

Model 5117-70 Aerial image, beam splitter and main projector head (triple head)

Model 5117-80 Aerial image, beam splitter, beam splitter aerial image, and main projector head (quadruple head)

5111 Step Printer for 1:1 35mm to 35mm, 35mm to 16mm and cinema-scope conversion. Also for 2:1 enlargement and reduction.

Master Series Stands and Cameras

Model 5442 Animation Stand with X-Y lens mount, Underneath Aerial Image Projection Head

Model 5443 Projection Filmstrip Stand (fixed registration film movement)

Model 5420 Process Camera 35/16 (fixed registration film movement)

Filmaker Series

Model 5332 Animation Stand (covered in this manual)
Animation Registration Devices

Model 5333 Filmstrip/Slide Stand (see inside back cover)

OXBERRY®

Filmaker 16mm Animation Stand and Camera **INSTRUCTION MANUAL**

for OXBERRY *Filmaker*, Model 5332-00

BERKEY TECHNICAL

25-15 50th STREET, WOODSIDE, N. Y. 11377 • TELEPHONE: (212) 932-4040

A DIVISION OF
Berkey
Photo Inc. 

Purpose

The end product is the developed film. The conditions necessary for the desired and economically feasible end product must be predictable and controllable by the producer. This unit gives the producer the ability of completely controlling the relationship between the film, lens and copy during photography, with predictable results and a minimum of effort.

Animation is the result of the photographer's ability to photograph the artwork and cels in the relationships necessary for one movement to flow smoothly into another.

The key to that ability is "registration." It is this unit's ability to maintain registration that allows the photographer to position cels for smooth movement devoid of "jumping" of the projected image on the screen. Registration is assured by the pegs in each peg track on the table top. Replacing one cel with another on the pegs will insure that the new cel's position relative to the camera will be the same.

This registration is maintained also in the camera by the intermittent registration pin that registers the film in the aperture and by the keyed column that allows vertical movement of the camera and the lens in registration to the compound.

However, the registration maintained during the photography will only be as good as that maintained during the execution of the artwork. The OXBERRY® cel punch and drawing disc described in this manual are for the purpose of insuring that all registration will meet the needs of the animator during photography.

Among conditions controlled by this unit are the following:

- The distance from the film to the copy (Reduction Ratio)
- The Focus
- The frame size
- The number of frames in sequence
- The incorporated copy in any photograph
- The orientation of the copy (registration)
- The exposure time
- The direction of advance
- The number of times one frame is exposed

Some of the conditions controlled may be modified on this unit at the option of the operator:

- The displacement of the copy (pans, tilts or spins)
- The plane of focus
- The exposure time
- The addition of filters
- The lens "f" stop setting
- Lighting

Those conditions not directly involved in film exposure have to be controlled separately from the unit:

- The type of film used
- The type and size of the copy
- The top lighting for photographing opaque copy
- Manner of film developing

Table of Contents

Introduction

Purpose

1.0 Camera

- 1.1 Film
 - 1.1.1 Loading
 - 1.1.2 Threading
- 1.2 Film Advance (Stop Motion Motor)
- 1.3 Sequence Control
- 1.4 Exposure Control
- 1.5 End of Film Indication
- 1.6 Film Take-Up
- 1.7 Camera Activation

2.0 Stand

- 2.1 Copy Mounting
- 2.2 Focus Mechanism
- 2.3 Camera Positioning
- 2.4 Reticle Projection

3.0 Controls (Console)

- 3.1 Film Exposure (Fades & Dissolves)
- 3.2 Film Advance
- 3.3 Frame Counter
- 3.4 Sizing

4.0 Lighting

- 4.1 Top Lighting
- 4.2 Under Lighting
- 4.3 Iris Setting

5.0 Maintenance of Equipment

6.0 Interchangeability with 5327-01 Filmstrip/Slide Camera

7.0 Installation Information

8.0 Glossary

9.0 Schematics

Accessories:

- 1.1.4 Magazine, 400 ft.
- 2.1.8 Floating Platen, 12 field
- 2.1.9 Floating Pegs
- 2.1.13 Underlighting Unit
- 3.2.2 Sequence Control Counter
- 3.3.2 Hand Control for Exposure and Sizing
- 3.3.3 Rotoscope

Accessories: (Cont'd)

Registration Devices:

- 2.1.10 Drawing Disc
- 2.1.11 Field Guide
- 2.1.12 Punch

Photographs:

- Fig. 1 Overall Stand
- Fig. 2 Camera Removal
- Fig. 3 Camera Prepared for Threading
- Fig. 4 Lifting Registration Pin.
- Fig. 5 Manually Transporting Film
- Fig. 6 Auxiliary Shutter Control
- Fig. 7 Table Top
- Fig. 8 Placing Cel on Peg Track
- Fig. 9 Art Work Positioned for Photography
- Fig. 10 Floating Pegs
- Fig. 11 Drawing Disc
- Fig. 12 Field Guide
- Fig. 13 Punch
- Fig. 14 Underlighting Unit
- Fig. 15 Focusing Knob
- Fig. 16 Light Projector Positions
- Fig. 17 Control Panel
- Fig. 18 Fade, Dissolve Curve and Camera Scale
- Fig. 19 Reticle
- Fig. 20 Hand Jog
- Fig. 21 Rotoscope
- Fig. 22 Iris Ring
- Fig. 23 5327-01 Filmstrip/Slide Camera
- Fig. 24 Combination Control Panel
- Fig. 25 Installation Drawing
- Chart 1 Shutter opening
- Inside Back Cover —
5333-00 Filmstrip/Slide Stand
- Back Cover — Typical Installation of 5332-00
- Schematics:
 - 5326-01 Camera Circuit
 - Zoom, Viewer and Underlighting Circuit
 - 5326-27 Combination Camera Circuit
 - Timer Circuit

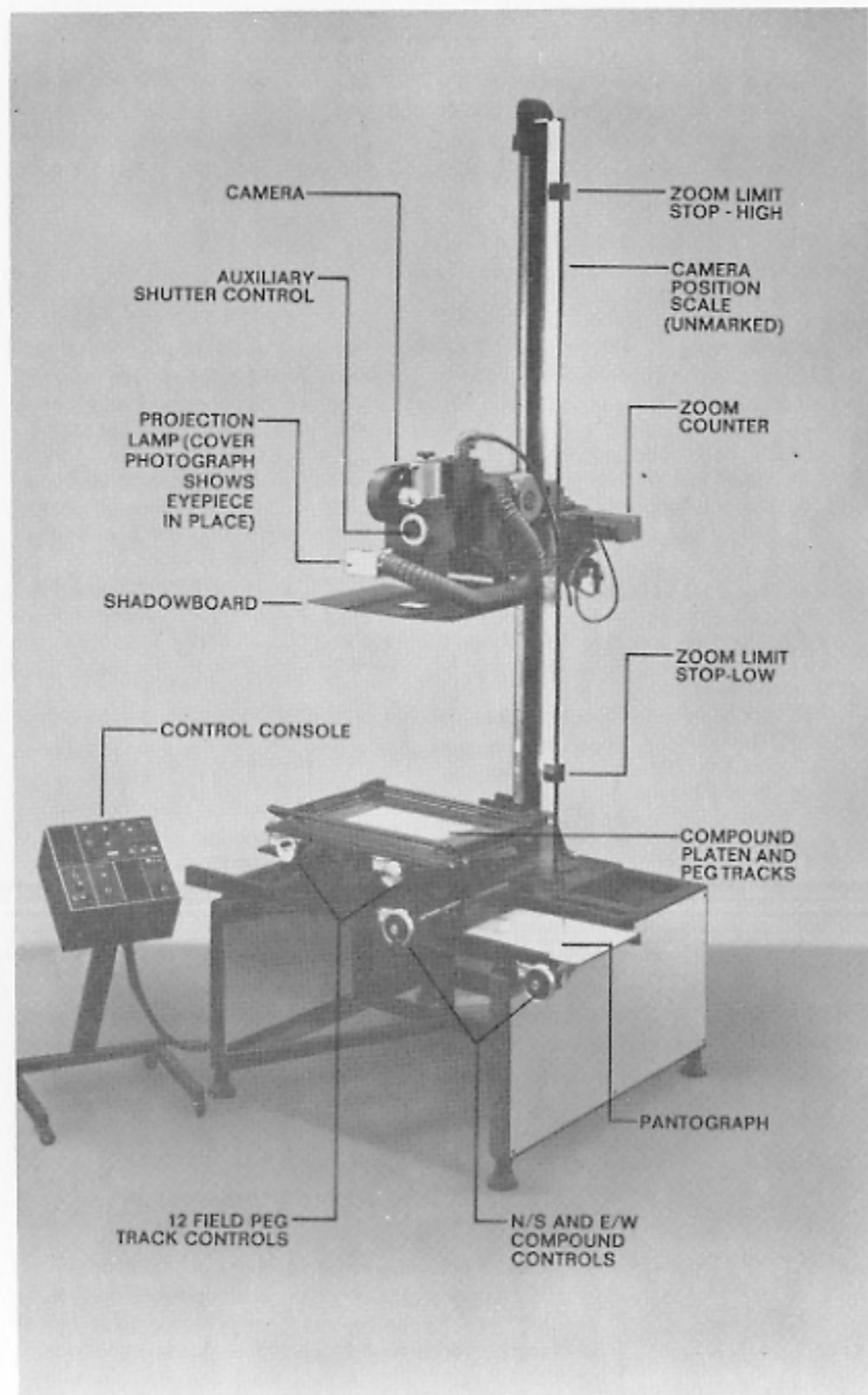

figure 1. Model 5332 Filmmaker 16mm Animation Stand and Camera.

1.0 Camera

1.1 Film: This camera is built to accept a 100' or 200' reel of daylight load, 16mm film, single or double perforated.

1.1.1 Loading: If it is desirable to load or unload the camera in a dark-room, removal of the camera from the stand is accomplished in the following manner:

a) First disengage the electrical connector attached to the top of the camera. (See Fig. 2a). Rotate the knurled portion of the connector counterclockwise until it is released and then pull the connector away from the camera.



figure 2a. Removing Electrical Connector.

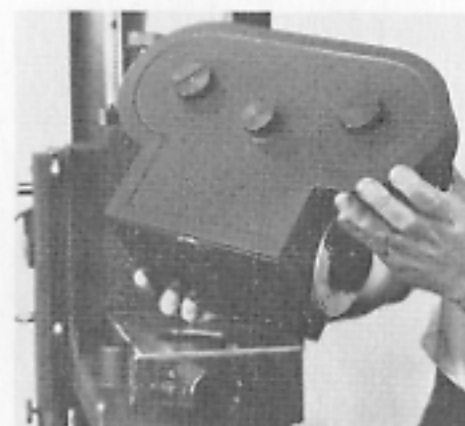

figure 2b. Removing camera from stand.

b) Release the locking lever (See Fig. 22) maintaining the camera in position.

c) Rotate the camera 45° and pick it up out of the bayonet slot. When removing camera from stand after photography, cover opening on the bottom with hand. This will prevent any extraneous light from entering camera. (See Fig. 2b).

1.1.2 Threading: There is a chart located on the back of the camera cover. This chart should be followed exactly when threading the camera. The chart shows two methods of threading. One method is followed when the camera is equipped with a magazine and shows the film coming from the top center. The second method of threading shown is used when the film is loaded directly into the camera. Clearance for threading the film is made in the following manner: (See Fig. 3).

a) Place the power switch in the off position.

b) Remove the camera cover by rotating the knurled knob in the center counterclockwise until the cover is released.

c) The isolation sprocket located just below and between the feed and takeup reels is exposed by rotating the knurled knob on the top of the guide roller units counterclockwise. Be sure the sprocket teeth enter the sprocket holes in the film before returning the guide rollers to their original position.

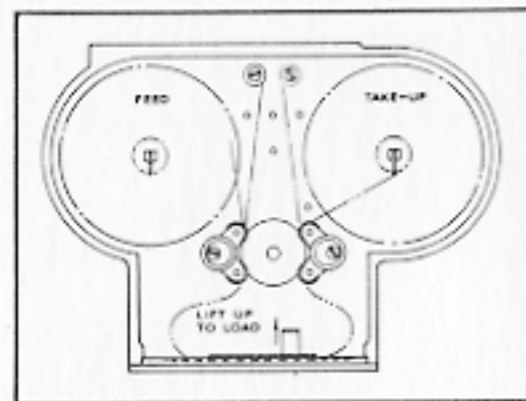

figure 3a. Threading diagram.

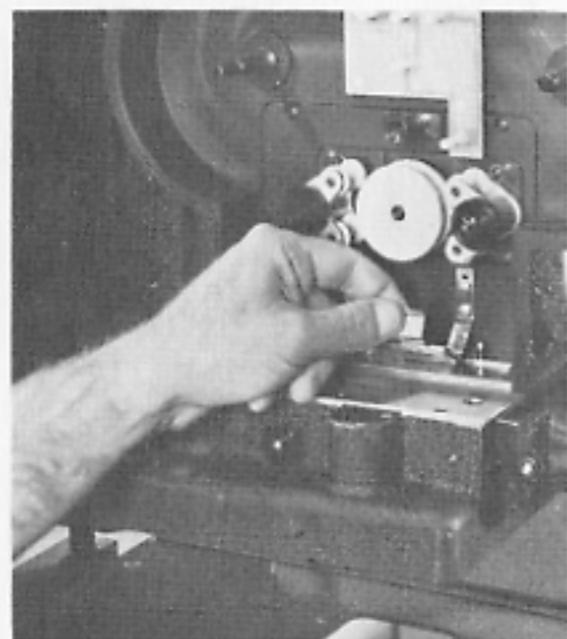

figure 3b.
Removing
pressure
plate.

d) The pressure plate is removed by lifting the lever located on the right of the plate until the plate clears the slot and then pulling the plate out. (See Fig. 3).

e) Lift the spring mounting the registration pin with fingernail until enough clearance is made to slip the film under it. Release the spring and slip the film along the slot until the pin enters a sprocket hole: if necessary, rotate motor manually until claw pin is raised. (See Fig. 5).

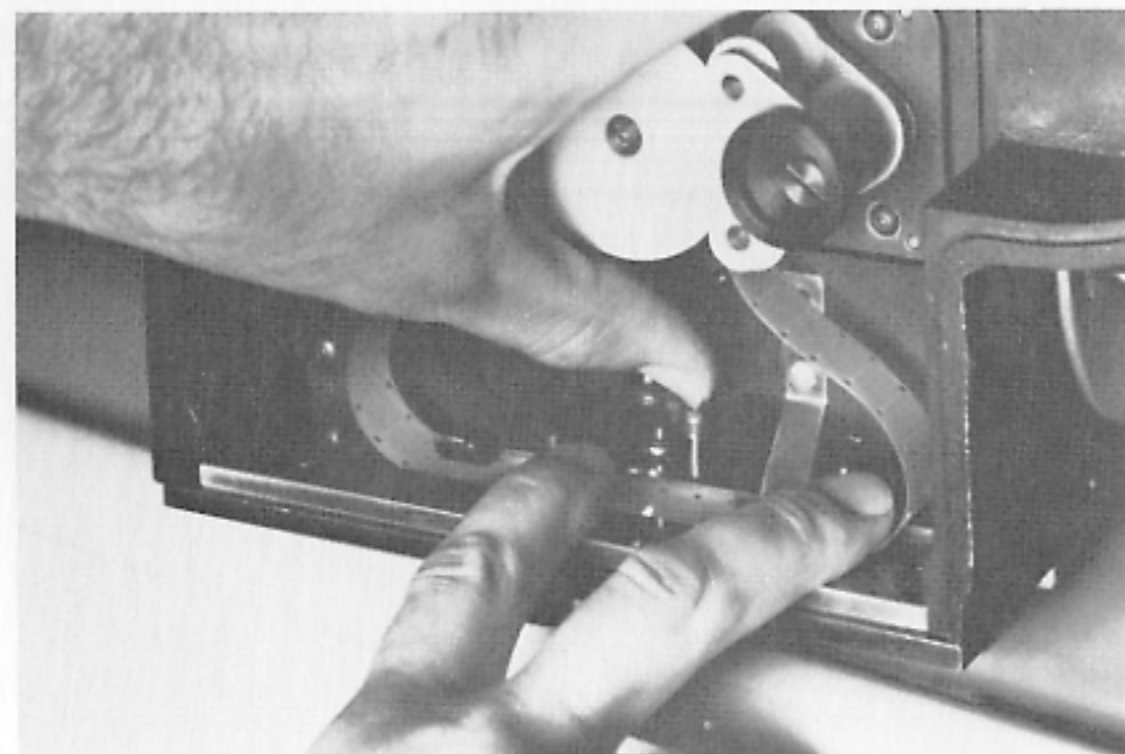

figure 4. Lifting intermittent registration pin to thread camera.

1.1.3 Manual Film Transport: By rotating the knob located on top of the stop motion motor, the film will be transported and can be checked for proper threading. This can only be done with the power switch in the "OFF" position. (See Fig. 5).

1.1.4 An accessory 16mm magazine (P/N 5326-31) capable of holding 400' of film is available for those users who require a larger film storage capacity and the convenience of magazine loading. This magazine mounts on an accessory adapter (P/N 5326-30).

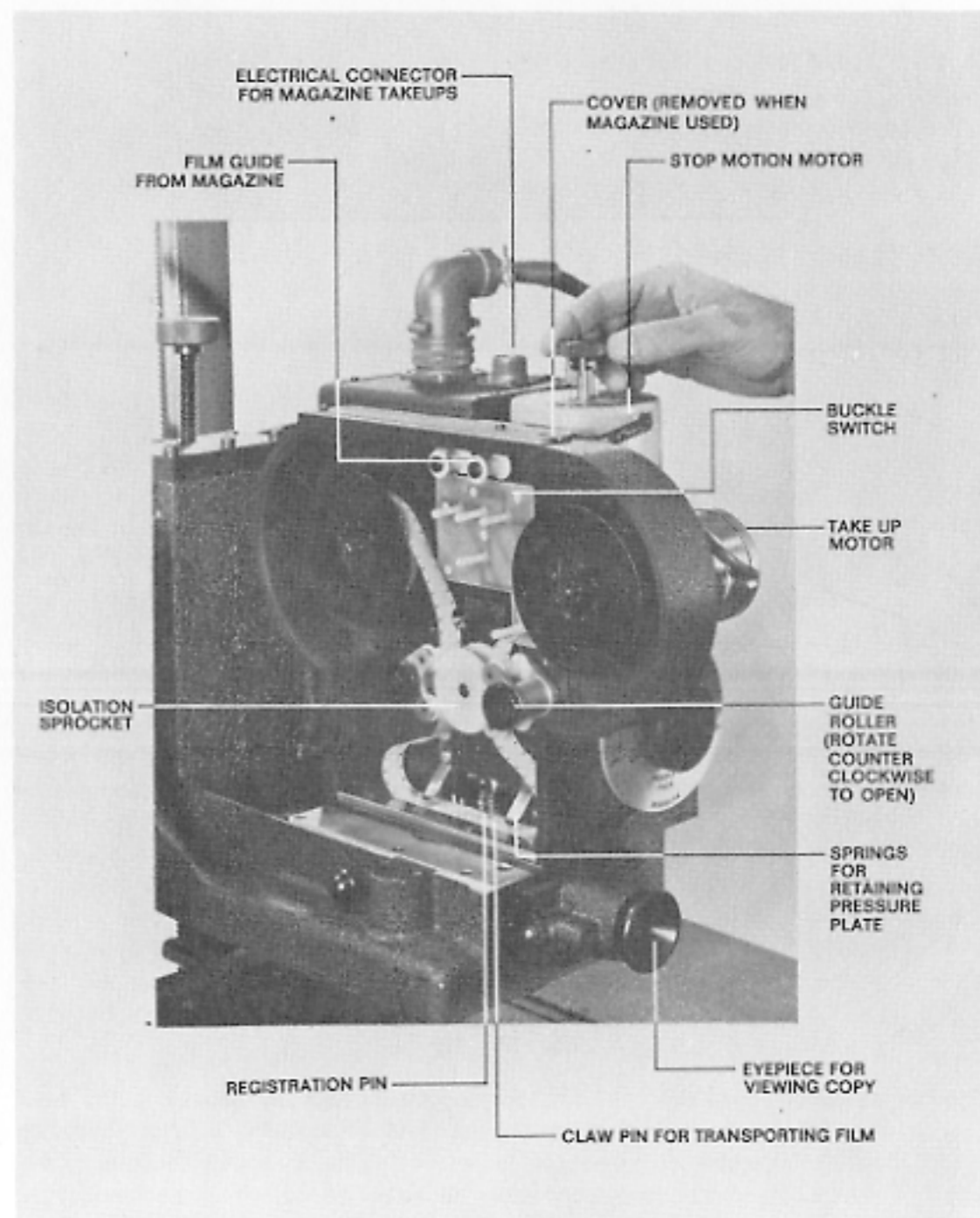

figure 5. Manually transporting film to check for proper threading. Power must be off when this is done.

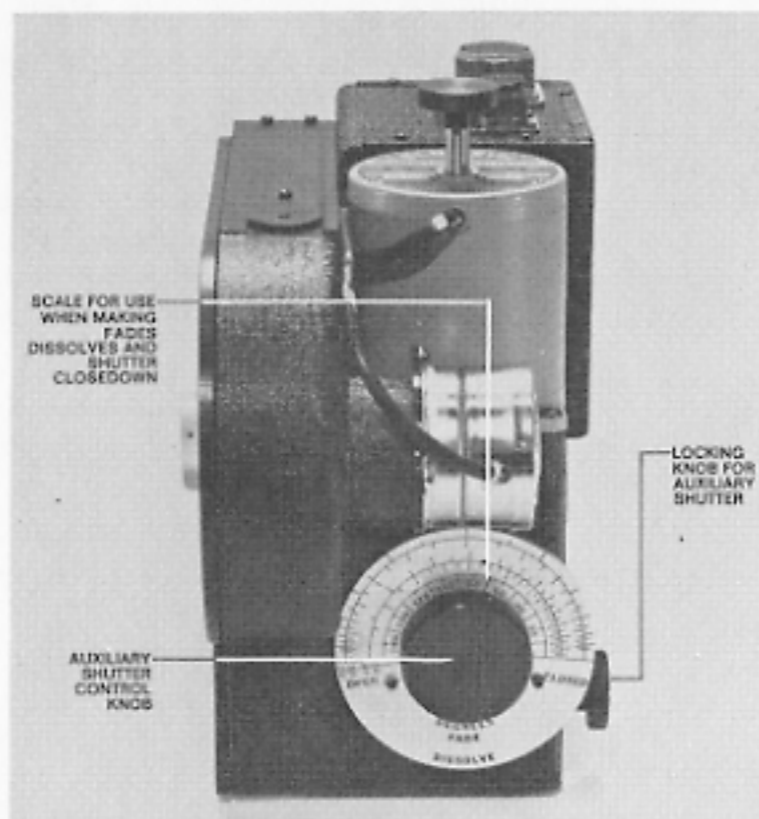

Figure 6.
Auxiliary
Shutter
Control.

- 1.2 **Film Advance:** The film will automatically be advanced at the rate of 180 frames per minute by a built-in stop motion motor each time the expose button (Item 8, Fig. 17) is pressed or as long as the mode selector (Item 3, Fig. 17) is on "CONT", continuous; if the film is properly threaded, power is on, the unit plugged into an outlet, and the Reset has been pressed.
- 1.3 **Sequence Control:** Each time the camera advances the film one or more frames, each frame is recorded by the counter reading changing the appropriate number of digits.
- 1.4 **Exposure:** A rotary shutter is provided with a 170° opening that will result in a 1/6 second exposure. A variable shutter is provided for reducing the exposure down to zero, for making dissolves and fades, and for transporting film without exposure. The variable shutter may also be used when exposures requiring less than the 170° opening are to be made (See Fig. 6)
- 1.5 **Buckle Switch:** A buckle switch is provided with the camera for use with the auxiliary 400' magazine. The camera will automatically stop with the shutter closed when this switch is activated by the film and a red indicator light (Item 5, Fig. 17) will glow.
- 1.6 **Tension:** When power is on, tension is automatically applied to the feed and take-up reels through their motors. When power is on and if there is no film on either or both reels, either or both knobs on the outside of the camera door will rotate constantly although the camera is performing no action.
- 1.7 **Activation:** The camera is controlled from the console (See 3.0)

2.0 Stand

The stand contains the drive mechanism for changing the vertical position of the camera, the compound on which the copy is mounted, the interlocks for preventing camera or lens damage from extreme raising or lowering of the camera carriage, the device for maintaining focus over the full range of the camera positioning, the light source for projecting the reticle when sizing, and an unmarked positioning scale (See Fig. 1).

2.1 **Copy Mounting on Compound:** The heart of this unit from the animator's point of view is the peg tracks-compound-rotation unit assembly. This unit provides the precise flexibility necessary for multi-cel positioning during animation photography.

2.1.1 An aluminum table top is provided mounted to a compound. This table top contains 4 sets of peg tracks and a removable insert supplied in metal, glass and foam rubber. (See Fig. 7)

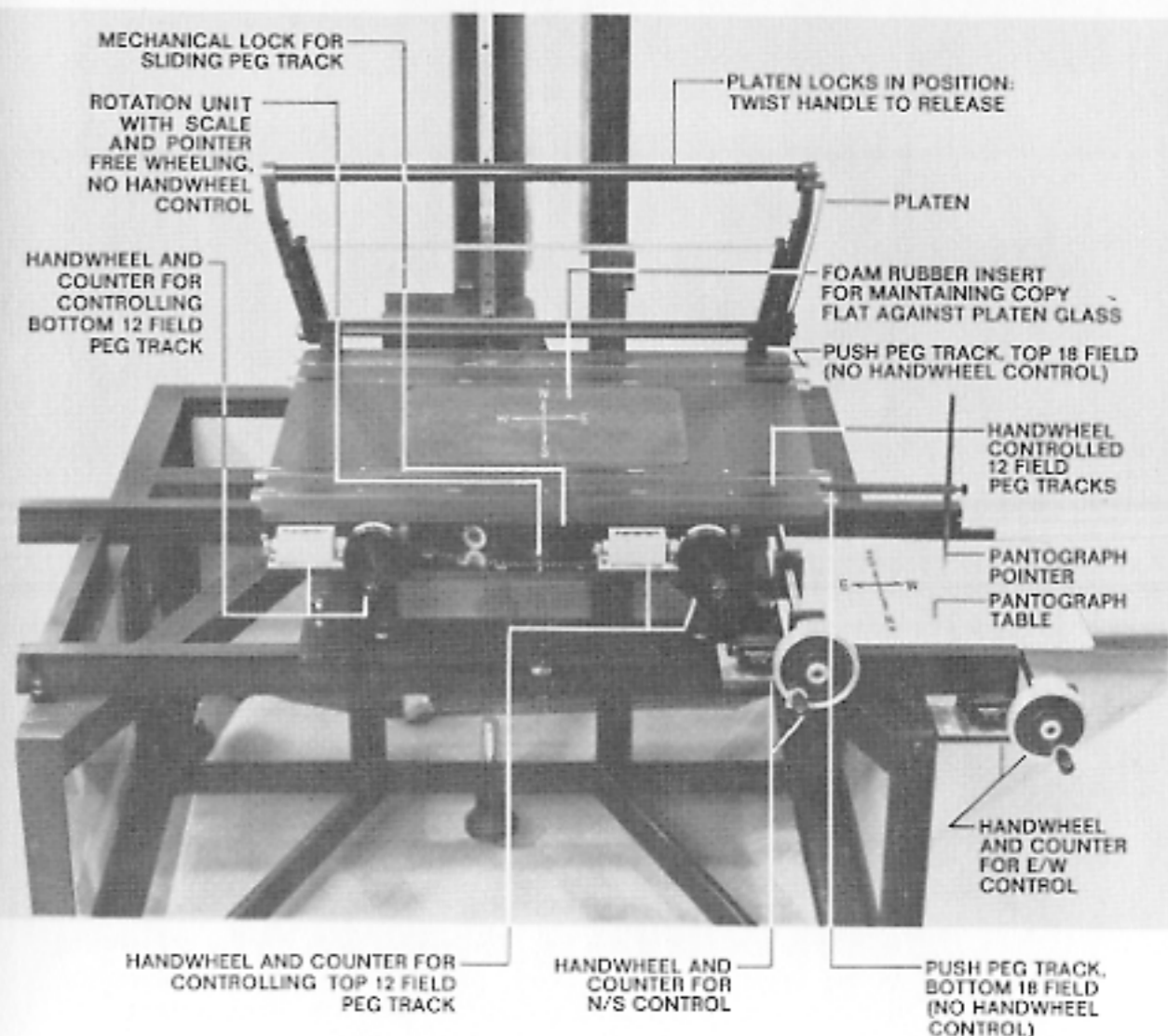

Figure 7. Compound and controls. As shown by arrows when the compound is moved North the camera is actually photographing the art work towards the South. Therefore the path on the Pantograph should have North towards the operator - North being the top of the art work.

2.1.2 Each peg track in the table top permits the replacement of a photographed cel with one to be photographed, while insuring that there will be no displacement of one cel's position from the previous cel's position. (See Fig. 8)

2.1.3 Each peg track is capable of being moved horizontally independently of the other peg tracks or the compound, i.e., this allows the background cel to be moved while the foreground cel remains in its same position relative to the lens. The two inner 12 field peg tracks are controlled by the handwheels in front of the table top. The right handwheel controls the track above the insert (top 12 field track), and the left handwheel controls the track below the insert (bottom 12 field track). A counter is located adjacent to the handwheel and each digital change of this counter represents one hundredth of a field of the peg tracks. The other two peg tracks (located top and bottom 18 field) are positioned by sliding or pushing them the necessary amount. Locks are provided on all peg tracks for maintaining cel position during photography and when replacing cels. The pegs may be removed by merely unscrewing them when it is necessary to photograph large art work. (See Fig. 9)

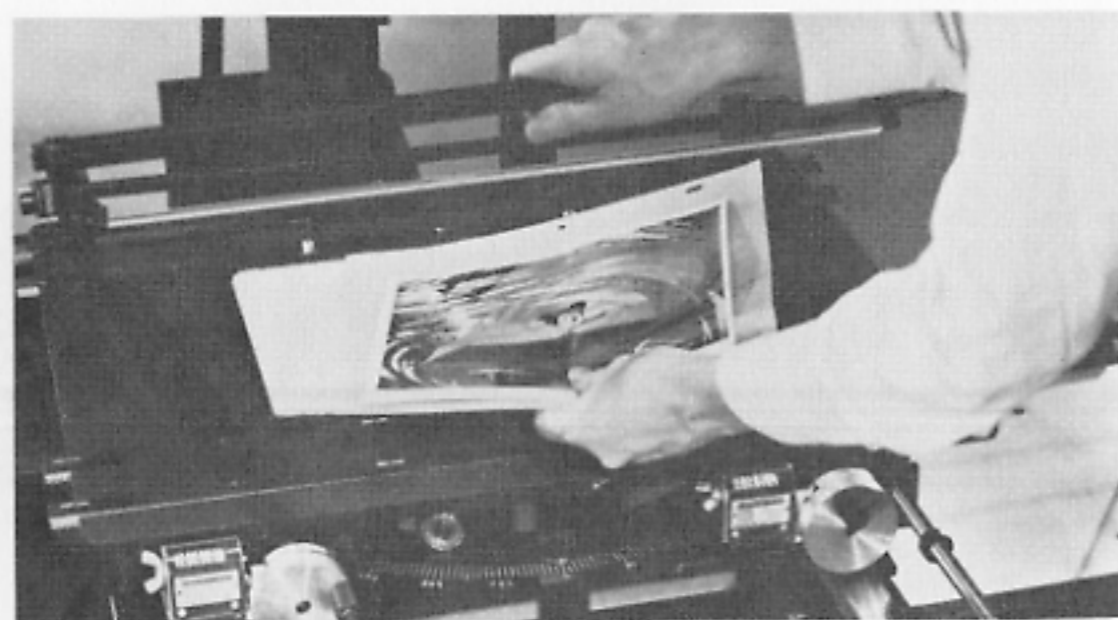

figure 8. Replacing cel to be photographed.

2.1.4 The shapes of the pegs are purposely different. The three pegs that are used to maintain the cel position are shaped in the following manner. Two pegs are oblong and one is round. The center peg is round so that it will exactly position the cel. The two oblong pegs prevent angular misadjustment of the cel. The center hole in the cel is exactly the size of the peg. The slotted holes in the cel exactly fit the thickness of the oblong peg, but are longer to allow the cel to be put on and taken off starting from both ends without marring the holes. When the unit is delivered peg tracks are provided with four oblong and three round pegs on each peg track. A cel may therefore be positioned directly on the optical axis, or to the left, or to the right of the optical axis as required.

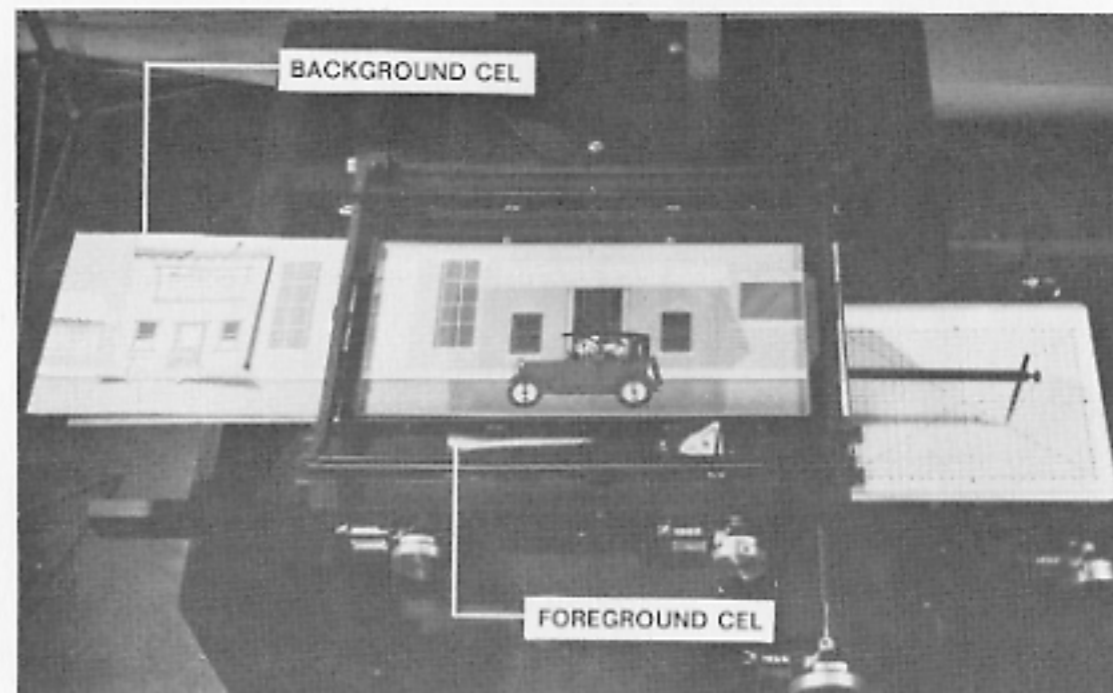

figure 9. Cels ready for photography

2.1.5 The compound E/W and N/S movements allow all cels to be moved the same amount in any given direction: combining these movements will result in a diagonal pan. The counter readings always denote the amount the compound centerline has been offset from the optical centerline. It is important to note that the amount of operator attention required for pans has been minimized by having counters on the compound controls read in hundredths of a field in both the N/S and E/W directions when the 28mm lens is in place, i.e. each digital change of the counter represents 100th of a field in the E/W direction and in the N/S direction. Each digital change of the counter represents one hundredth of a field in the E/W direction and in a N/S direction. Note: When returning the compound or peg tracks to zero, always rotate the handwheel in a clockwise direction. If they must be turned counterclockwise, then go past the zero indicator a few turns and come back to it in a clockwise direction.

2.1.6 The rotation unit will rotate all of the cels the same amount. An arrow indicates on a 360° scale the amount the rotation unit has been offset from the "O" position. (See Fig. 7). A lock is provided for maintaining the position of this unit. Releasing the lock will allow the unit to be rotated by hand to the necessary position.

2.1.7 A platen is provided for maintaining flatness of cels or copy. When lifted it will lock in the up position and is released by rotating the platen handle. The foam rubber provided with the stand is used in conjunction with the platen and presses the cels or copy against the bottom of the water-white glass in the platen. (See Fig. 7)

2.1.8 A pantograph is located adjacent to the compound. By placing below the needle the path to be followed on the art work, the exact position of the compound relative to lens on that path will always be known (See Fig. 9).

2.1.9 A rollaway unit (P/N 5330-85) is available for use with oversize art work. When the compound is moved for panning with the platen fixed to it, and if the art work is appreciably larger than 12 field, the edge of the platen may interfere with the photography. The platen is attached to the unit by two allen screws and will not move with the compound because it is fixed to the stand, and therefore, regardless of how much the compound is moved, will always remain in exactly the same position under the camera. (See Fig. 10)

2.1.10 Floating pegs (P/N 5330-86) are available for use in conjunction with the Rollaway assembly (P/N 5330-85). When cels are attached to these pegs they may be held stationary or moved N/S up to 3" independently of the cels fixed to the peg tracks on the table top. This unit is capable of a 1/2" up and down adjustment to allow for variations in thickness of material on table top. (See Fig. 10). Pegs cannot be used in top peg tracks when this unit is used.

2.1.11 Drawing discs are available for maintaining the position of the cels during the drawing of the artwork. These drawing discs contain pegs that are duplicate of the ones used on the table top. This insures that when the cels drawn on those discs are placed on the compound, the artwork will be in the exact position necessary relative to the pegs. When placed in table or light box, the drawing disc may be rotated so that the artwork is normal to the animator regardless of the angle required on the cel. A 16 3/8" diameter hole is required in the light box or table top to accept this unit. (See Fig. 11).

2.1.12 A 16mm field guide (P/N 5400-78) is available as a standard reference to the animator. It outlines the specific sizes — 1 through 12 field — that can be photographed proportional to the projection aperture. (See Fig. 12).

2.1.13 A punch (P/N 5400-05-01) is available for progressively punching peg holes in paper and cels with the accuracy necessary for proper registration. (See Fig. 13).

2.1.14 An underlighting unit (P/N 5330-35) is available for use in conjunction with the glass insert in the table top for photographing pencil tests, etc. This unit receives five 110V bulbs that are not supplied. The plastic insert supplied with this unit must be placed in the table top when the unit is used. This insert is frosted to prevent the filaments showing through the clear area in the transparency. (See Fig. 14).

2.2 Focus: The focus is automatically maintained over the full range (3 field to 22 field) of camera positions through a mechanical arrangement that changes the film plane as necessary.

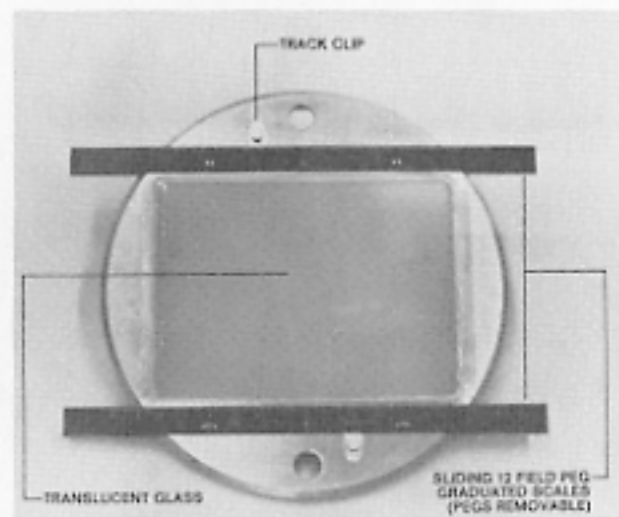
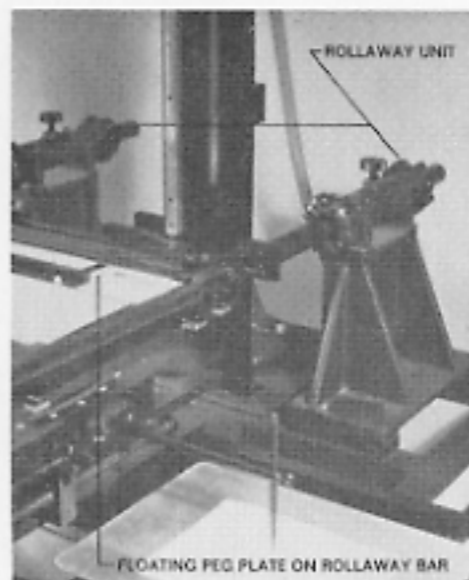

figure 10.

figure 11.

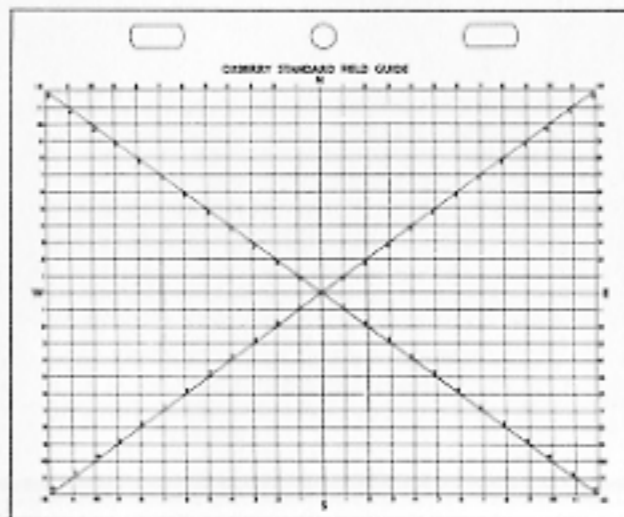

figure 12.

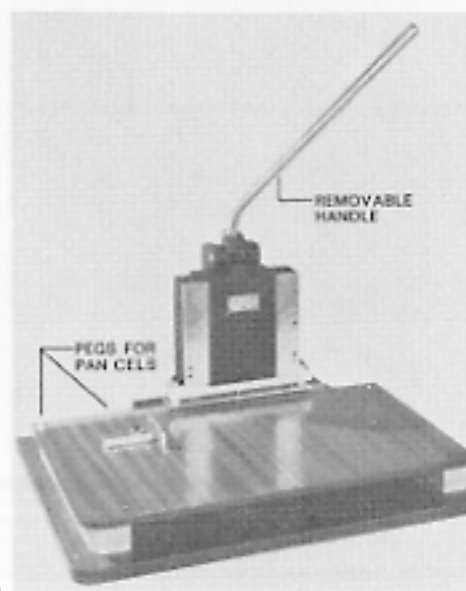

figure 13.

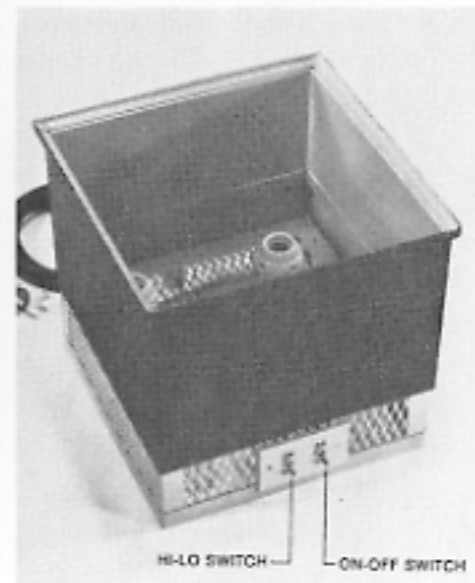

figure 14.

AVAILABLE ACCESSORIES

figure 10. Rollaway Unit.

figure 11. Drawing Disc.

figure 12. Field Guide.

figure 13. Progressive Punch.

figure 14. Underlighting Unit.

b) 1/6 second exposure-multiple frames automatically: Set advance selector (Item 9) at "Fwd." (Forward) or "Rev." (Reverse) and, only when ready to proceed with the photography, set the mode selector (Item 3) at "Cont." (Continuous).

c) Less than 1/6 second exposure — one frame: Set controls as in "a" and turn knob controlling the auxiliary shutter (See Fig. 6) until pointer points at desired opening on degrees scale. Lock auxiliary shutter in place by rotating knob (See Fig. 6) clockwise until snug.

d) Less than 1/6 second exposure — multiple frames automatically: Set controls as in "b". However, before selecting continuous mode, turn the auxiliary shutter control knob (See Fig. 6) until the pointer points at the desired opening on degrees scale. Lock the auxiliary shutter in place by rotating knob (See Fig. 6) clockwise until snug. (See Chart 1.)

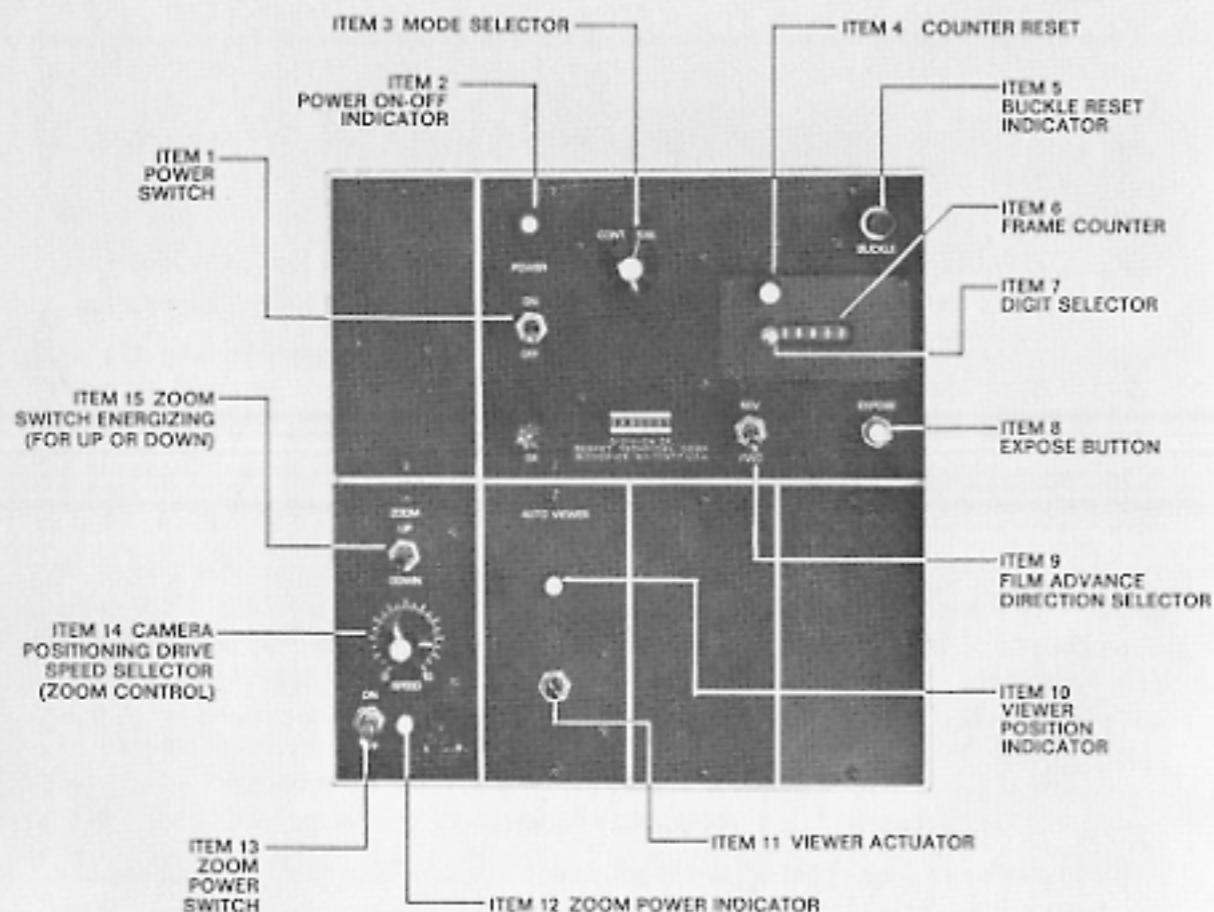

figure 17. Control Console.

3.1.2 *Fades*: Fades may be made by selectively using the auxiliary shutter when exposing each frame. When making fades the mode selector must be set at "S.M." (Stop Motion) and kept there until the fade is complete. The scale for the fade is marked 24 and 32. These figures represent the number of frames that will be incorporated in the fade when an exposure is made at each cross line on the scale from open to closed or vice versa. (See Fig. 18).

a) 24 frame fade: Turn knob controlling auxiliary shutter from "Open" until indicator is on first cross line (short) on the top half of the scale. Press the "Expose" button, and after the action is completed rotate indicator to the next line (long). Press "Expose" button. Continue this procedure making an exposure at each cross line until "Closed" is reached. The result will be a fade out. If the indicator is moved from "Closed" to the first cross line and so on until "Open" is reached, the result will be a fade in.

b) 48 frame fade: If the procedure outlined in "a" is followed and in addition an exposure is made at a point in between each line, the result will be a 48 frame fade.

c) 12 frame fade: If the procedure outlined in "a" is followed but exposures made only at the long cross lines, the result will be a 12 frame fade.

d) 32 frame fade: If the procedure outlined in "a" is followed but on the bottom half of the scale, the result will be a 32 frame fade.

e) 64 frame fade: If the procedure outlined in "a" is followed on the bottom half of the scale, and, in addition, an exposure is made at a point in between each line, the result will be a 64 frame fade.

f) 16 frame fade: If the procedure outlined in "a" is followed on the bottom half of the scale but exposures made only at the long cross lines, the result will be a 16 frame fade.

3.1.3 *Dissolves*: Dissolves may be made by selectively using the auxiliary shutter when exposing each frame. When making a dissolve, the mode selector must be set at "S.M." and kept there until the dissolve is complete. The scale for the dissolves is marked 24 and 32. These figures represent the number of frames that will be included in the dissolve when an exposure is made at each cross line. Before starting a dissolve, check the reading on the frame counter, or set that counter at "0" as described in 3.2.1 b). Overlapping a fade in and a fade out will not result in a pleasing dissolve. See Chart 1.

NOTE: If the Combination Console shown in 6.0 has been supplied, (Item 4, Fig. 24) must be in the "ADV/26" position and the Mode Selector, Item 3, Fig. 24, must be in the "Stop Motion" or "Continuous" position for the Animation Camera to respond as described in this section.

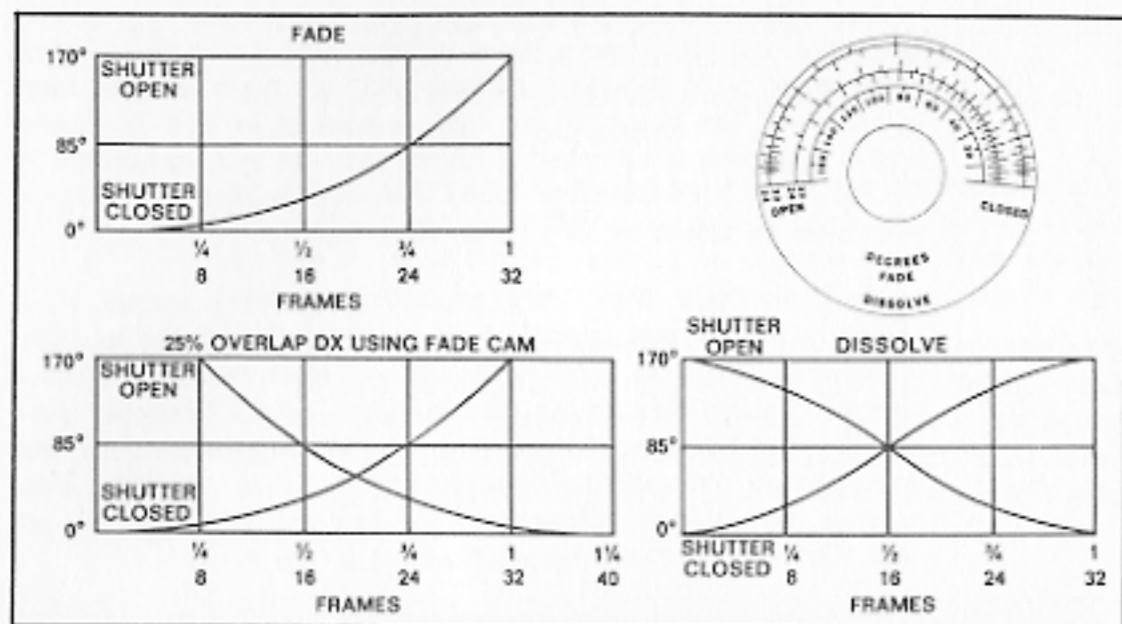

figure 18. Density variations resulting from use of camera fade and dissolve scale.

- a) 24 frame dissolve: Place the advance selector (Item 9, Fig. 17) in "Fwd." (forward). Turn the knob controlling the auxiliary shutter from open to the first cross line (short) on the top half of the scale and press the "Expose" button. Rotate the knob until the indicator is on the next line (long) and press the "Expose" button. Continue this procedure until "Closed" is reached. Leave the shutter in the "Closed" position and place the advance selector in the "Rev." (Reverse) position. Activate unit until the frame counter reading is the same as the reading was when the dissolve was started. Place the advance selector in "Fwd", forward. Rotate the auxiliary shutter from closed to the first cross line (short) next to the closed position. Lock the shutter and press the "Expose" button. Continue this procedure until "Open" is reached. The result will be a 24 frame dissolve.
- b) 48 Frame Dissolve: If the procedure outlined in "a" is followed and in addition an exposure is made at a point between each line also, the result will be a 48 frame dissolve.
- c) 12 Frame Dissolve: If the procedure outlined in "a" is followed but exposures made only at the long cross lines, the result will be a 12 frame dissolve.
- d) 32 Frame Dissolve: If the procedure outlined in "a" is followed but on the bottom half of the scale, the result will be a 32 frame dissolve.
- e) 64 Frame Dissolve: If the procedure outlined in "a" is followed but on the bottom half of the scale, and, in addition, an exposure is made at a point in between each line also, the result will be a 64 frame dissolve.
- f) 16 Frame Dissolve: If the procedure outlined in "a" is followed on the bottom half of the scale but exposures made only at the long cross lines, the result will be a 16 frame dissolve.

3.1.4 The auxiliary shutter scale marked in degrees is closest to the control knob. Exposures of less than 1/6 second are made by rotating the knob to the proper degree setting on the scale and locking it in place. (See Chart 1).

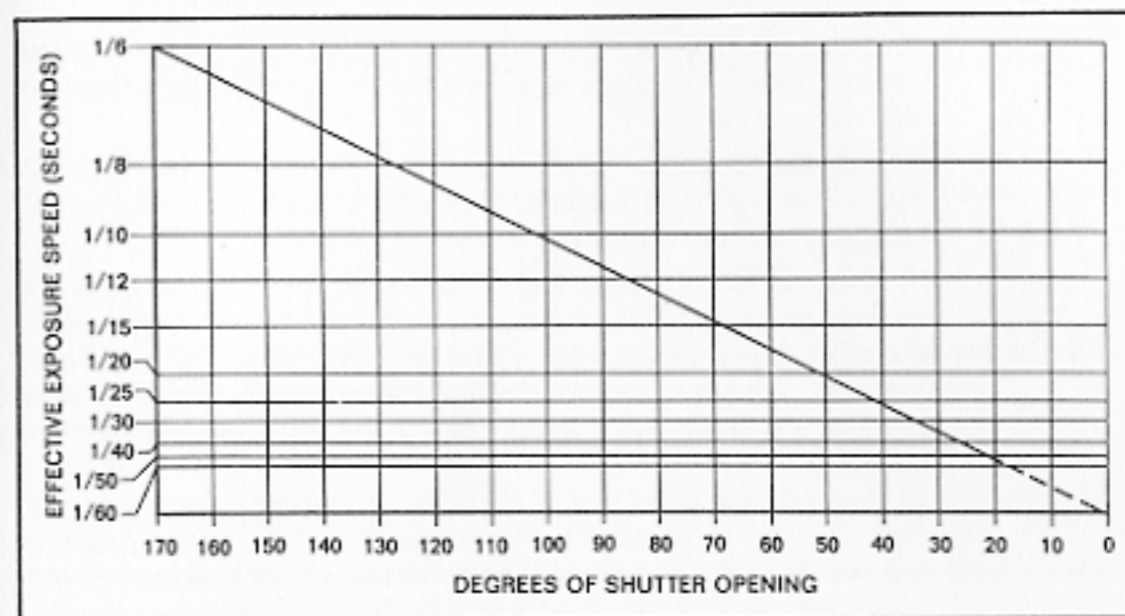

chart 1. Speed changes resulting from auxiliary shutter slowdown.

3.2 Frame Counter: (Item 6, Fig. 17)

3.2.1 The function of this counter is to constantly denote the number of frames advanced in any sequence. The action of the counter is as follows:

- a) The counter will change its reading by the number of frames the film advances. It will add when the film is advanced forward and subtract when the film is advanced in reverse.
- b) The counter may be reset to "0" by pressing the button (Item 4, Fig. 17) in and releasing. If this is done at the start of each sequence, the operator will have an indication through each sequence as to how many frames have been advanced.
- c) If it is necessary to change the count on the counter for any reason, the Digit Selector (Item 7, Fig. 17) is provided for this purpose.
- d) This counter will only count advances and not exposures. The film may be advanced without exposure and the counter reading will change with each advance.

3.2.2 A predetermining counter (P/N 5320-74) is available for controlling the number of frames that will be included in any sequence. When a count is set and that count is reached, the unit will be inoperable signifying to the operator the end of the sequence.

3.3. Sizing:

3.3.1 Sizing is accomplished in the following manner:

- Remove the projection lamp from the holding bracket and place it on the viewer as shown in Fig. 16. Place the toggle switch in the "auto" or "on" position.
- Press the "Viewer" actuator (Item 11, Fig. 17) momentarily and release. When the viewer is in position, the indicator light (Item 10, Fig. 17) will glow.
- Activate the zoom motor: Place the zoom power switch (Item 13, Fig. 17) in the "ON" position. The indicator light (Item 12, Fig. 17) will glow when the switch is in the "on" position.
- Select speed of zoom motor: Rotate knob (Item 14, Fig. 17) to the midway position. NOTE: Experience with the unit will dictate when the zoom motor should move faster or slower than this: In general, for short changes of camera position slower speeds should be used and for long changes of camera position the faster speeds are more desirable.
- Energize the zoom motor: Push the energizing switch (Item 15, Fig. 17) either up or down for the camera direction needed and hold the switch until the camera position is correct as indicated by the projected reticle. The reticle is marked with three rectangles. The smallest rectangle is dotted and allows for a 25% cutoff for T.V. The next larger rectangle indicates the area that will be projected on the screen. The largest rectangle indicates the area that will be exposed on the film. (See Fig. 19)

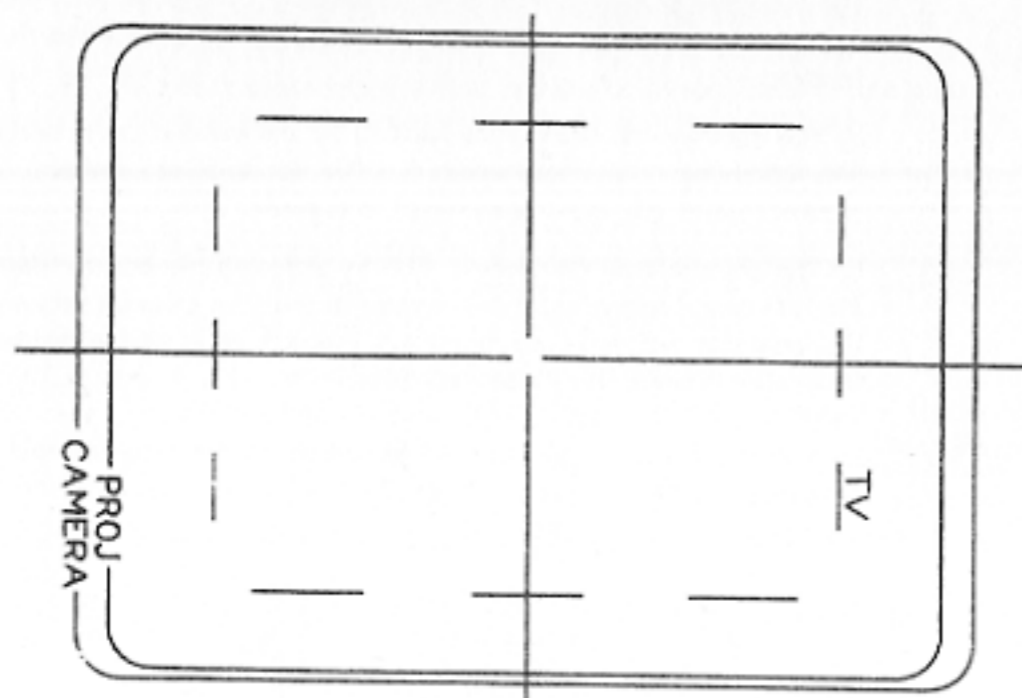

Figure 19. Reticle Markings Note: Outer rectangle shows the area of the film that will be exposed. This is larger than the area of the film that will be projected on the screen, to keep dust and lint that may collect in the aperture from marring the projected image.

f) Deactivate the zoom circuits: Place the zoom power switch (Item 13, Fig. 17) in the "OFF" position. This precaution will avoid the possibility of the camera being accidentally moved during the photography.

g) Return the viewer to its normal position: Press the "viewer" actuator (Item 11, Fig. 17) momentarily and release. If the toggle switch controlling the projection lamp was placed in the "ON" position, place it in the "OFF" position.

h) Sequential change of sizing: Place self-adhering tape on the unmarked positioning scale and mark the tape at the necessary intervals for each exposure. The camera is then moved to the successive markings on the tape after each exposure.

3.4 Zooms: This unit provides the user with the ability to make either a stop motion zoom or a continuous zoom.

3.4.1 A stop motion zoom is made in the following manner:

a) Place self-adhering tape on the unmarked scale. Mark the tape at the beginning of the zoom and the end of the zoom. Mark in between in such a manner that the spacing between the frames in the beginning and at the end of the zoom is less than in the middle of the zoom. When sequential frames are exposed at each mark, this procedure will result in a zoom that will have a slow start and a slow stop and give a pleasing effect on the screen.

3.4.2 A continuous zoom is made in the following manner:

a) After positioning the camera for the start of the zoom as described in 3.3, turn the rheostat (Item 14, Fig. 17) as far as it will go counterclockwise and mark the scale for the end of the zoom.

b) A dry run is made first to check the speed at which the zoom should be made for the number of frames to be incorporated.

c) Turn the rheostat (Item 14, Fig. 17) as far counterclockwise as it will go, close the auxiliary shutter, mark down the frame counter reading and the zoom counter reading.

d) Place the mode selector in continuous and turn the rheostat slowly clockwise, increasing the rate of turning until the maximum desired speed is reached. As the end of the zoom is neared, turn the rheostat counterclockwise slowing as it approaches the end of the scale.

e) Check the frame counter reading against the original reading to determine if the number of frames is correct. NOTE: It may be desirable to try this without film a few times the first time this type of zoom is attempted in order to get a "feel" of the control. It should be borne in mind that deterioration occurs in the sprocket holes each time they are transported and because of this the film should be transported as little as possible.

f) Return the film and the camera position to the original readings. Open the auxiliary shutter and proceed as detailed in (d).

g) This type of zoom when done correctly will approximate exactly the required zoom, i.e., if a sixty frame zoom is wanted this may result in a 58 or 64 frame zoom. If it is imperative that the zoom start and stop at exactly the proper field and exactly the number of frames, then the stop motion techniques should be used.

3.4.3 *Hand control:* An accessory controller (P/N 5330-21) for holding in the hand is available for controlling camera position and exposing film. This device is especially useful when making zooms, fades and dissolves. (See Fig. 20).

3.4.4 *Rotoscope:* A rotoscope (P/N 5326-30) is available for projecting developed film on to the table top when animation is to be made from live action scenes or for tracing outline of a section of a live action scene when preparing travelling mattes. After swinging door on pressure plate is out of the way, this unit is placed in the camera and the projection lamp is placed on it. The rotoscope will automatically open the shutter when assembled in the camera and project the film in the aperture on to the table top. The film may be transported while the rotoscope is in place. (See Fig. 21).



figure 20. Hand Control for camera positioning and film exposure.

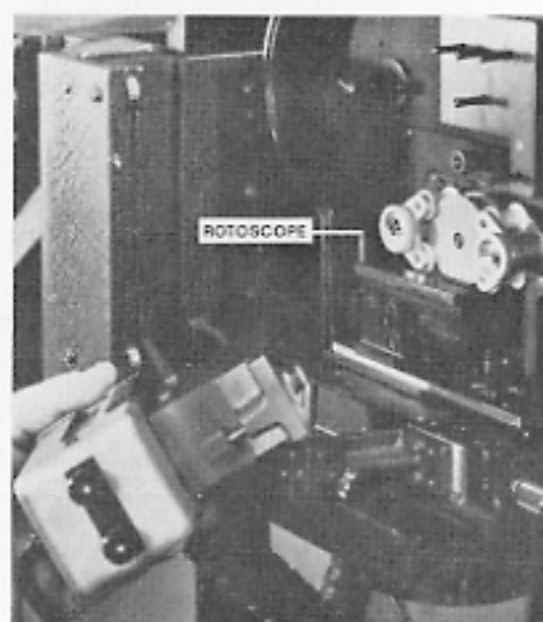

figure 21. Placing projection lamp on Rotoscope.

4.0 Lighting

The varied uses to which this equipment can be applied preclude the supplying of top lighting. ColorTran® lights of the following type are recommended for most applications:

Housing	LQK/5WYA
Lamp	1355-32
Accessory Holder	DRK-5
Barn Door	134QK-5
Stand	SS-13LA
Heat Glass	160-7

4.1 *Top Lighting:* Before setting up top lights run the camera to a comfortable height for viewing. Press the "Viewer" actuator and look through the eyepiece at the copy. Check for any extraneous light such as ceiling reflections that may result in highlights on the developed negative. Eliminate any highlights by placing a screen between the unwanted light and the unit or paint the reflecting surface flat black.

a) Set up lights on either side and above the table top directed at the copy. Check the amount of light and coverage at the copy when the lights are on with a photographic exposure meter. Set the proper "f" stop setting for the speed of the film being used against the 1/6 second shutter speed.

b) Select the proper iris setting by rotating the ring (See Fig. 22) until the line on the ring and the proper "f" stop number line up. (See 3.1.4).

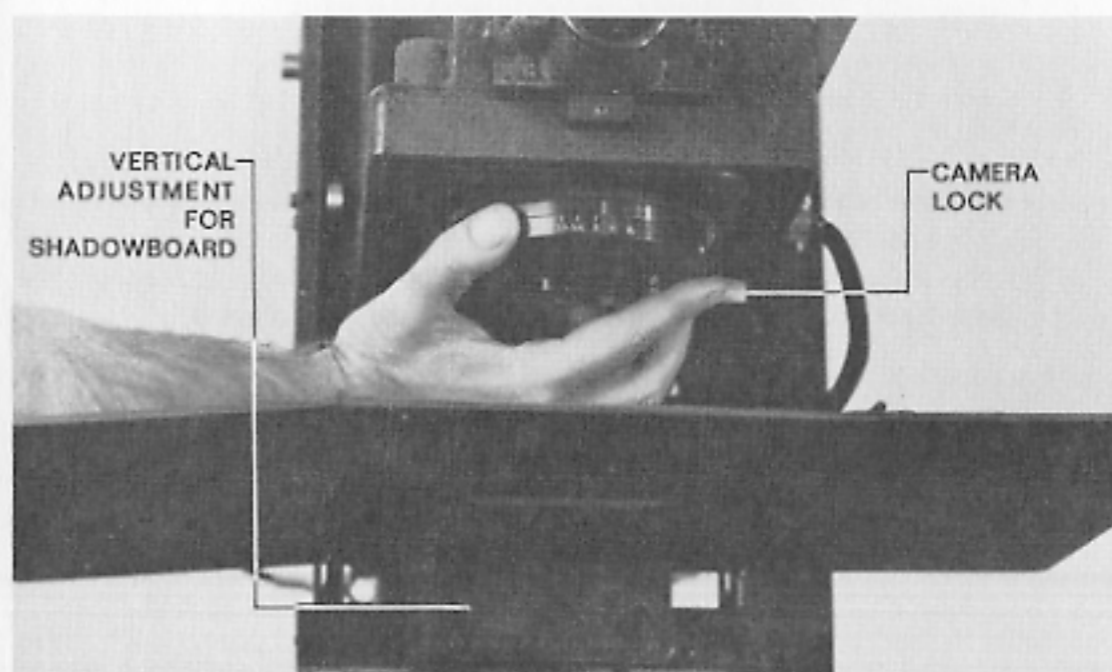

figure 22. Rotate Iris Ring until line on ring lines up with proper "f" stop number.

4.2 *Underlighting:* Be sure the glass and the plastic in the table top is cleaned thoroughly when using underlighting.

5.0 Maintenance

The importance of maintaining a clean unit and a clean environment cannot be over-emphasized. Dirt, dust, gum and film chips are the antithesis of satisfactory photographic results. The following precautions taken wherever possible will aid in keeping the unit and the area as dust free as possible.

a) Do not put this unit in a room normally used for access from one part of the facility to the other. A dead-ended room will keep the amount of dust allowed in from the outside to a minimum.

- b) A slightly higher pressure maintained in the room housing the unit will keep dust from entering from other areas. A double entrance lead-in will also be of help.
- c) If cleaning is done by vacuum only and not by sweeping, and if the vacuum exhaust is located outside of the room, dust will also be kept to a minimum.
- d) If the room is swept, the floor should be dampened to keep the dust from swirling.
- e) A dust cover should be draped over the camera and lens when the unit is not in use.
- f) The lens should be cleaned once a week or each time it is inserted with lens tissue or silicon-impregnated paper ("Sight Savers", sold in optical and drugstores).
- g) The glass insert should be cleaned thoroughly each time before insertion.
- h) The camera should be brushed out thoroughly each time before loading film. Special attention should be given to the film path and aperture.
- i) The sprocket guides and pressure plate should be cleaned every thirty days with a cleaner equivalent to Trichloroethylene.
- j) It is also desirable to refrain from smoking in the area containing this unit. The residue in the smoke will cling to all the glass surfaces and the lens causing a deterioration in the quality of the photography.

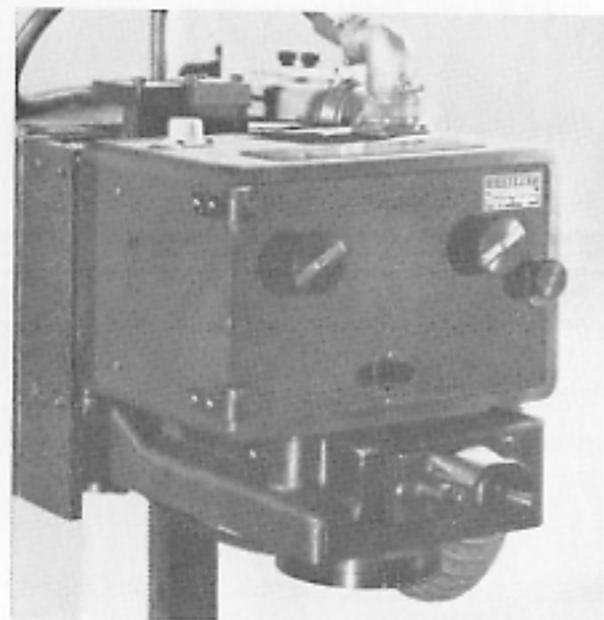

figure 23.
Model 5327-01 Filmstrip/Slide Camera.

6.0 Interchangeability of Camera

In addition to the animation camera supplied with this unit (5326-01), the unit can be equipped at the factory to also receive the 5327-01 Filmstrip Slide Camera. When this option is included the following instructions apply and the control panel shown in Fig. 24 is provided.

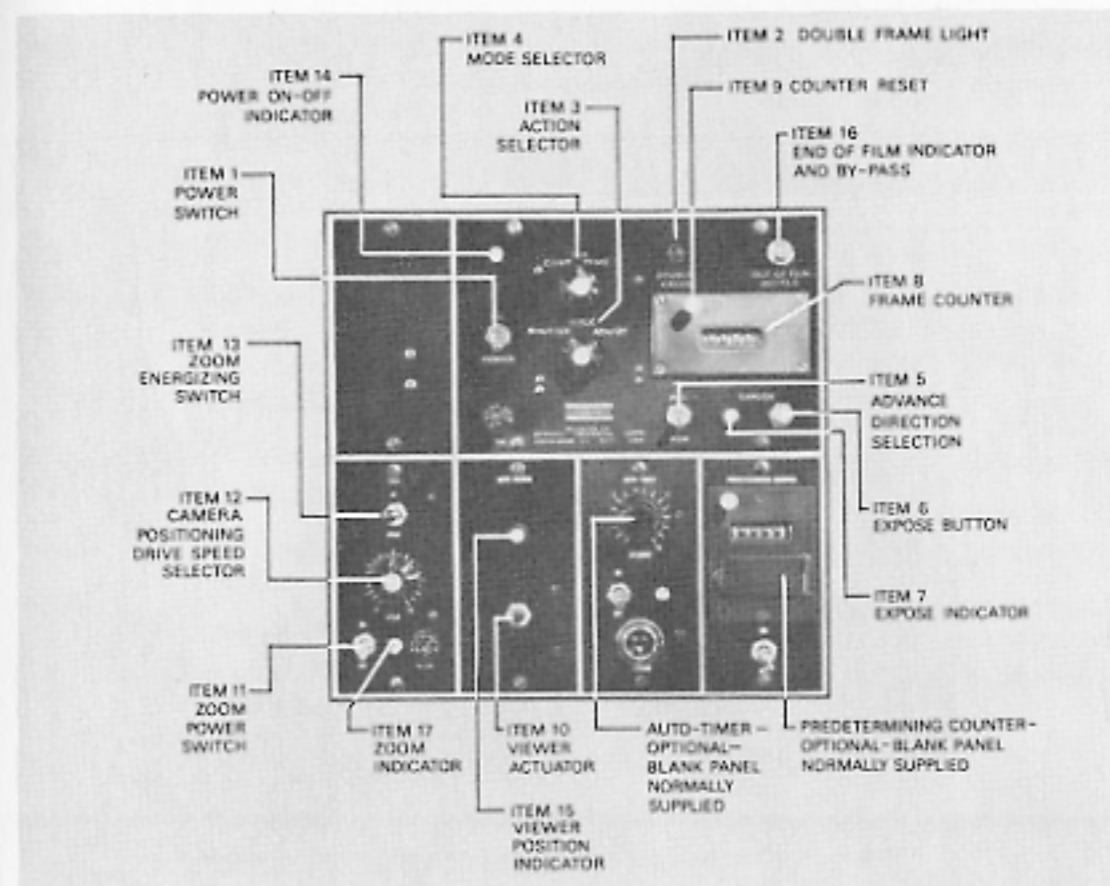

figure 24. Combination Control Panel.

- 6.1 *Reticle Correction:* Behind the eyepiece is a metal mask. If the eyepiece is removed, this mask with its lens can be slipped out of the unit. When the eyepiece is put back and the 5320-52, 28mm lens replaced with the 5320-50, 55mm lens, it will be possible to see three rectangles in addition to the three rectangles previously seen. The additional reticle markings are for use with the 5327-01 camera.
- 6.2 *Reticle:* All three of the new rectangles are larger than the rectangles used for 16mm photography with the 5326-01 camera. The largest rectangle delineates the area that will be exposed on the 35mm film for double frame (slide) photography and is the same size as the aperture in the camera. The area between the largest rectangle and the next larger delineates the portion that will be masked by the Eastman Kodak mount. The third rectangle from the outside delineates the area of the copy that will be incorporated in a single frame exposure.
- 6.3 The 5326-01 Camera is removed from the Stand as described in 1.1.1 and replaced with the 5327-01 Camera. The Instruction Manual for the 5333-00 Filmstrip/Slide Stand provides the necessary operating instructions for using the 5327-01 camera and its controls.
- 6.4 *Provision for Filmstrip/Slide Camera:* If it is desirable to purchase only the animation camera initially with provision for adding the Filmstrip/Slide Camera in the future, this may be done by ordering P/N 5320-71. However, P/N 5320-50, the 55mm lens, and P/N 5330-12 & 13, the focusing cam for the 55mm lens, should be purchased with the initial order. Stands will require return to the factory to have film planes matched.

7.0 Installation Information

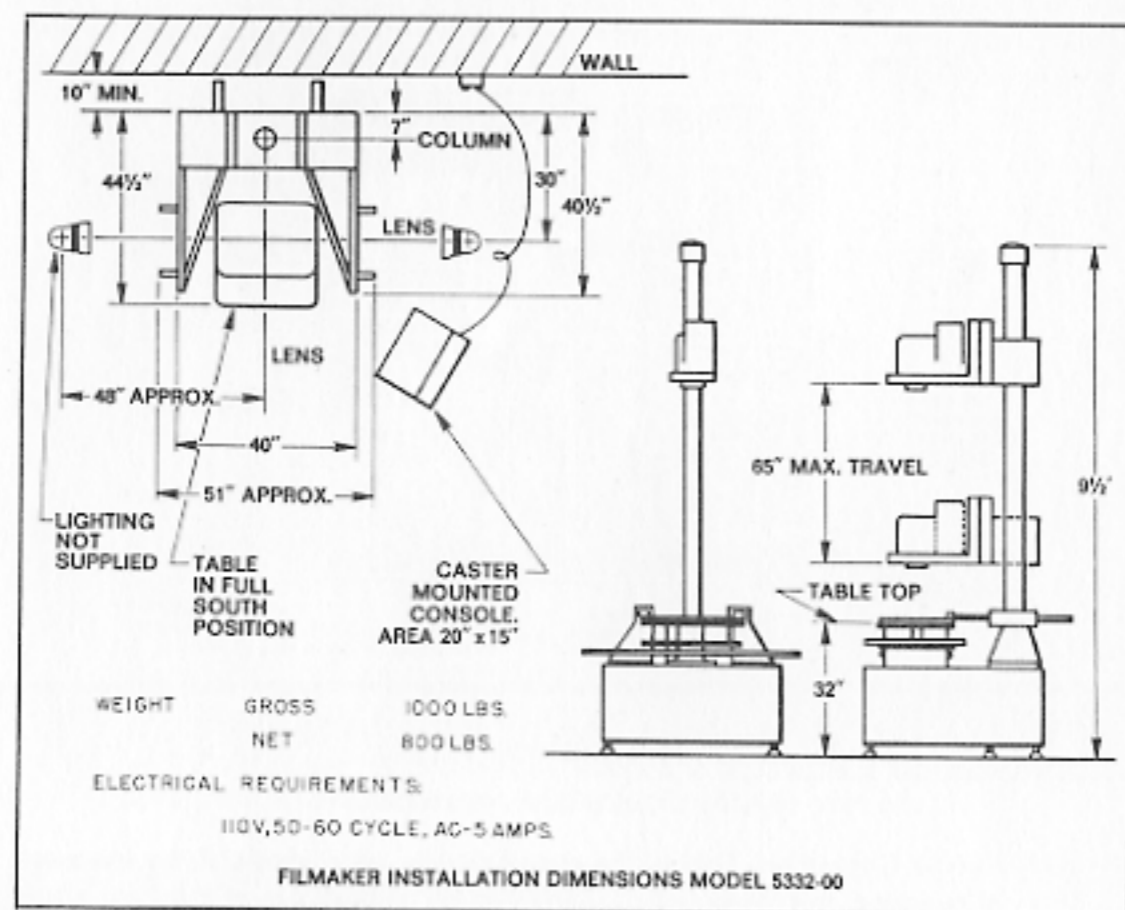

Figure 25. Typical installation plan of OXBERRY Filmmaker Model 5332-00 Animation Stand and Camera.

8.0 Glossary

- Animation:** The movement imparted to still figures and objects on the viewing screen through discrete photography. This movement may be as simple as a moving point or as involved as several figures moving against a moving background.
- Aperture:** An opening between the shutter and the film that controls the area of film exposed.
- Aerial Image:** The discrete focusing of a projected image in a plane where it may be photographed with additional material.
- Auto-focus:** The ability of a camera to maintain focus over the entire photographic range without the necessity of the operator making any adjustments.
- Buckle Switch:** A device to indicate improper film transport and to interrupt further film transport until correction is made.
- Cel:** A drawing for animation, on clear acetate.
- Compound:** A device for precisely moving the table top mounted to it for pans, tilts and spins.
- Copy:** The art work to be photographed.

- Dissolve:** The fading out of one scene while a new scene is simultaneously fading in. Also called a cross dissolve.
- Fade:** The effect of progressively changing the exposure of a scene through a given number of frames. If the exposure is progressively reduced until the scene is blacked out, it is a fade out. If the exposure is progressively increased from blackout to full exposure, it is a fade in.
- Field:** The size of the area of the copy to be included in a photograph. A twelve field would signify twelve inches of copy measured horizontally. The vertical measurement would be proportional as in the aperture.
- Field Guide:** A cel that indicates the proportional copy that will be photographed at any given field.
- Frame:** The image incorporated in a single exposure on motion picture film.
- Matte:** A film mask used to keep a portion of a frame from being exposed. The portion of the frame protected will be exposed against other art work later, while at that time the part that was exposed will be protected by a reverse matte.
- Pan:** The movement of the copy or the cel across the lens.
- Pencil Test:** The exposing of pencil drawings against film using underlighting so that the animation may be checked for correctness.
- Punch:** A device for discretely punching holes in cels in a manner required for proper registration on pegs.
- Raw Stock:** Unexposed film.
- Registration, Film:** The discrete positioning of the image on the film relative to the sprocket holes.
- Registration, Art:** The discrete positioning of the cel or the copy relative to the lens and previously photographed art work.
- Resolution:** The limit of the ability of a lens to discriminate when properly focused a set distance from an object: the resolution is usually expressed in lines per millimeter. A lens that at a fixed distance clearly shows 80 lines per millimeter has a higher resolution than a lens that cannot discriminate over 20 lines per millimeter at the same distance.
- Reticle:** A glass containing markings delineating the copy that will be included in a photograph.
- Rotoscope:** A device used in combination with a projection lamp for projecting exposed film from the camera through the aperture and lens onto a table top.
- Shuttle:** A device for precisely registering film in the aperture and transporting film in a precise matter.
- Slide:** A single frame of film made for still projection.
- Truck:** The combination of a zoom and pan, sometimes referred to as an off-center zoom.
- Zoom:** The movement of the camera toward or away from the copy.

9.0 Schematics

The schematics included in this area are of the functional type for rapid trouble shooting. For color-coding and wire numbers and exact location of components, wiring schematics are available from the factory.

5326 CAMERA CONTROL CIRCUIT

NOTES:

- THE FOLLOWING OPTIONAL EQUIPMENT IS INCLUDED IN THIS SCHEMATIC:
 - PREDETERMINING CONTROL LOCATED ON LINE 31
 - MAGAZINE TAKEUP LOCATED ON LINES 6-7-8 AND 12-13-14

- CIRCUITS SHOWN THIS IS SUPPLIED WHEN OPTIONAL EQUIPMENT IS ORDERED.

- COMPONENTS MARKED ARE IN THE CONTROL CONSOLE. ALL OTHER COMPONENTS ARE LOCATED IN THE CAMERA.

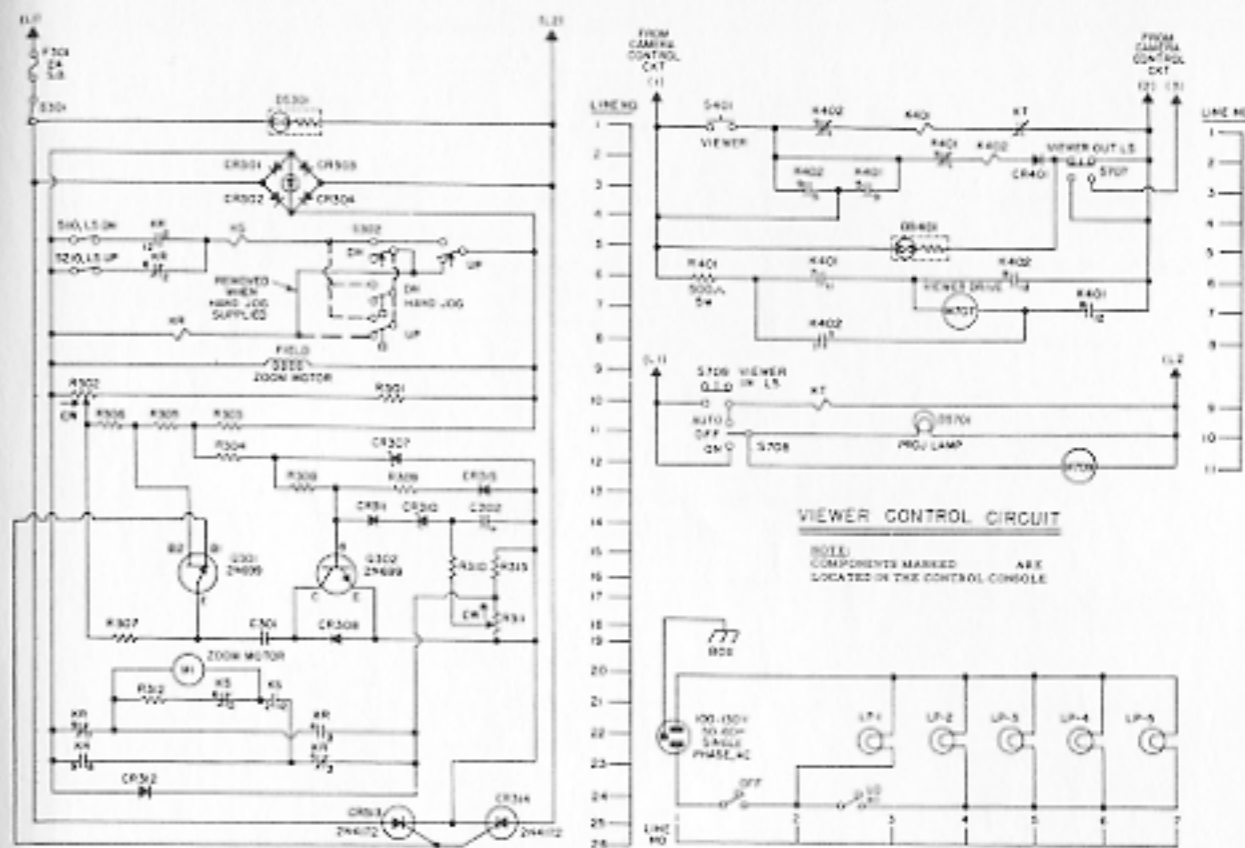
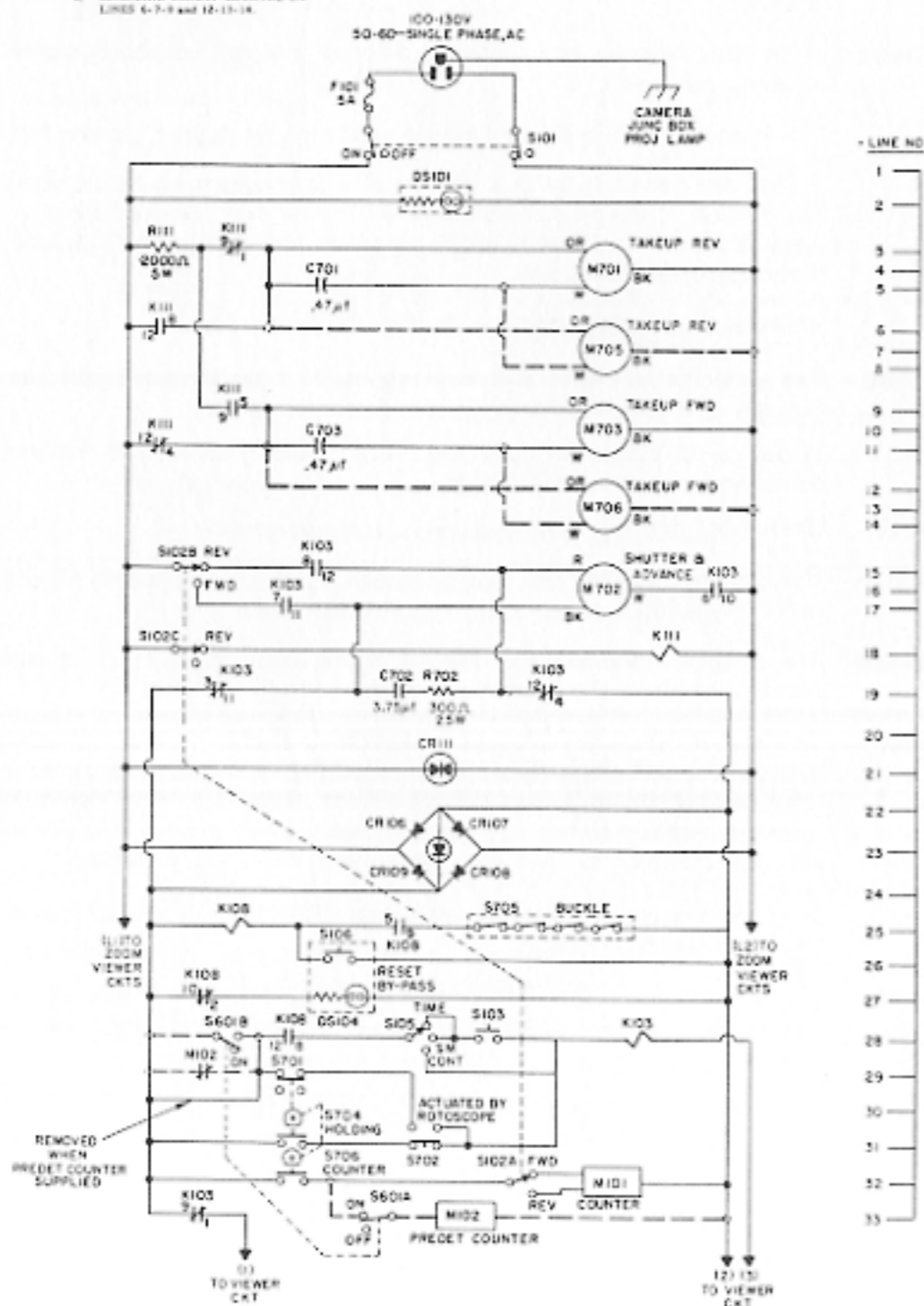

5326-27 CAMERA CONTROL CIRCUIT
(SHOWN WITH 5326 CAMERA IN PLACE)

NOTES:

1. THE FOLLOWING OPTIONAL EQUIPMENT IS INCLUDED IN THIS SCHEMATIC:

- a) PREDETERMINING COUNTER LOCATED ON LINE 42
- b) TIME CONTROLS AND INTERLOCKS LOCATED ON LINES 1 AND 4
- c) MAGAZINE TAKEUPS LOCATED ON LINES 12-17 OR 44 45-49-50

2. CIRCUITRY SHOWN THIS WAY IS SUPPLIED WHEN OPTIONAL EQUIPMENT IS ORDERED.

3. COMPONENTS MARKED WITH A SHADY BOX ARE LOCATED IN THE CONTROL CONSOLE. ALL OTHER COMPONENTS ARE LOCATED IN THE CAMERA.

4. CONNECTIONS SHOWN WITH A DASHED LINE ARE CONNECTED WHEN 5327 CAMERA IS IN PLACE.

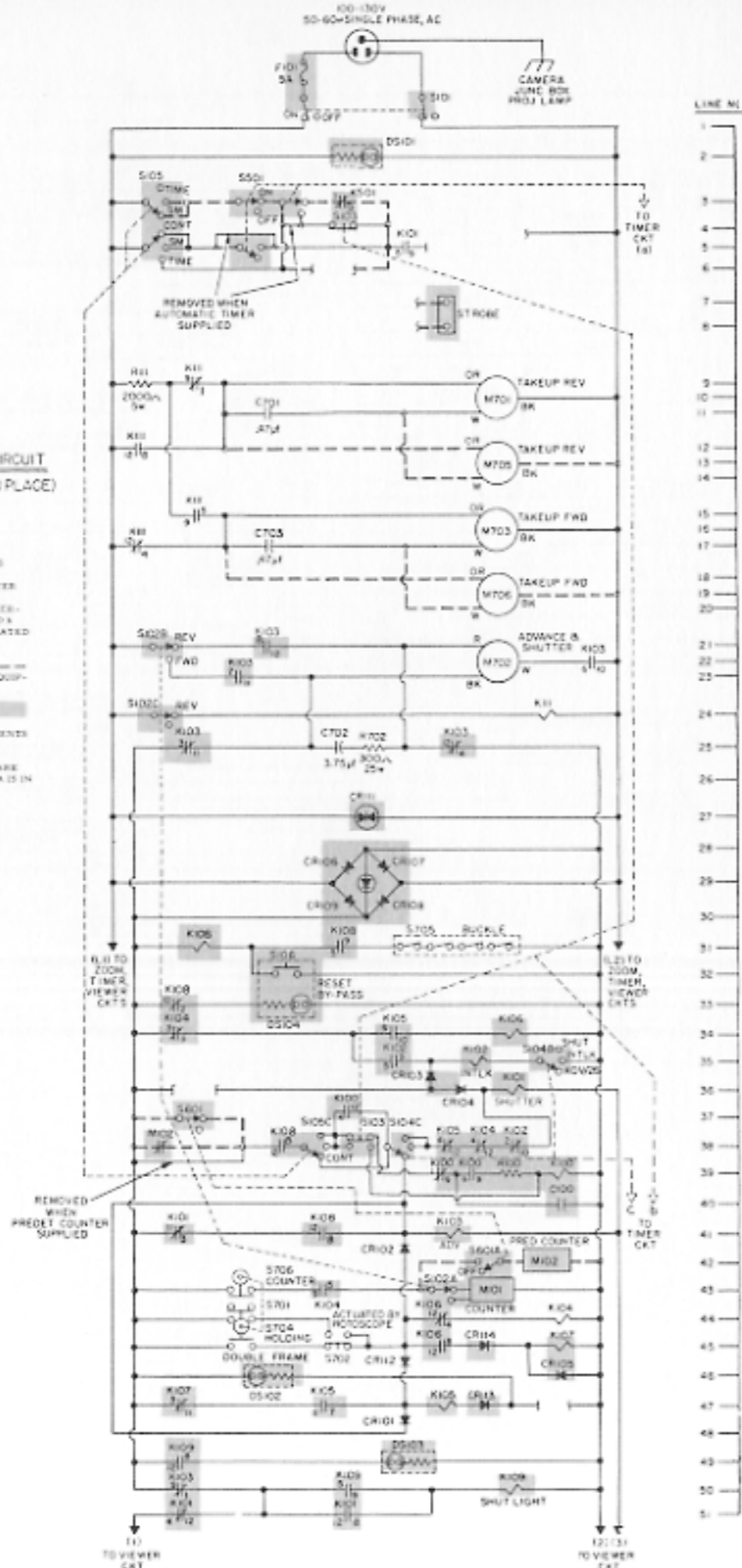

OXBERRY 35mm Filmstrip/Slide Stand and Camera

MODEL 5333-00

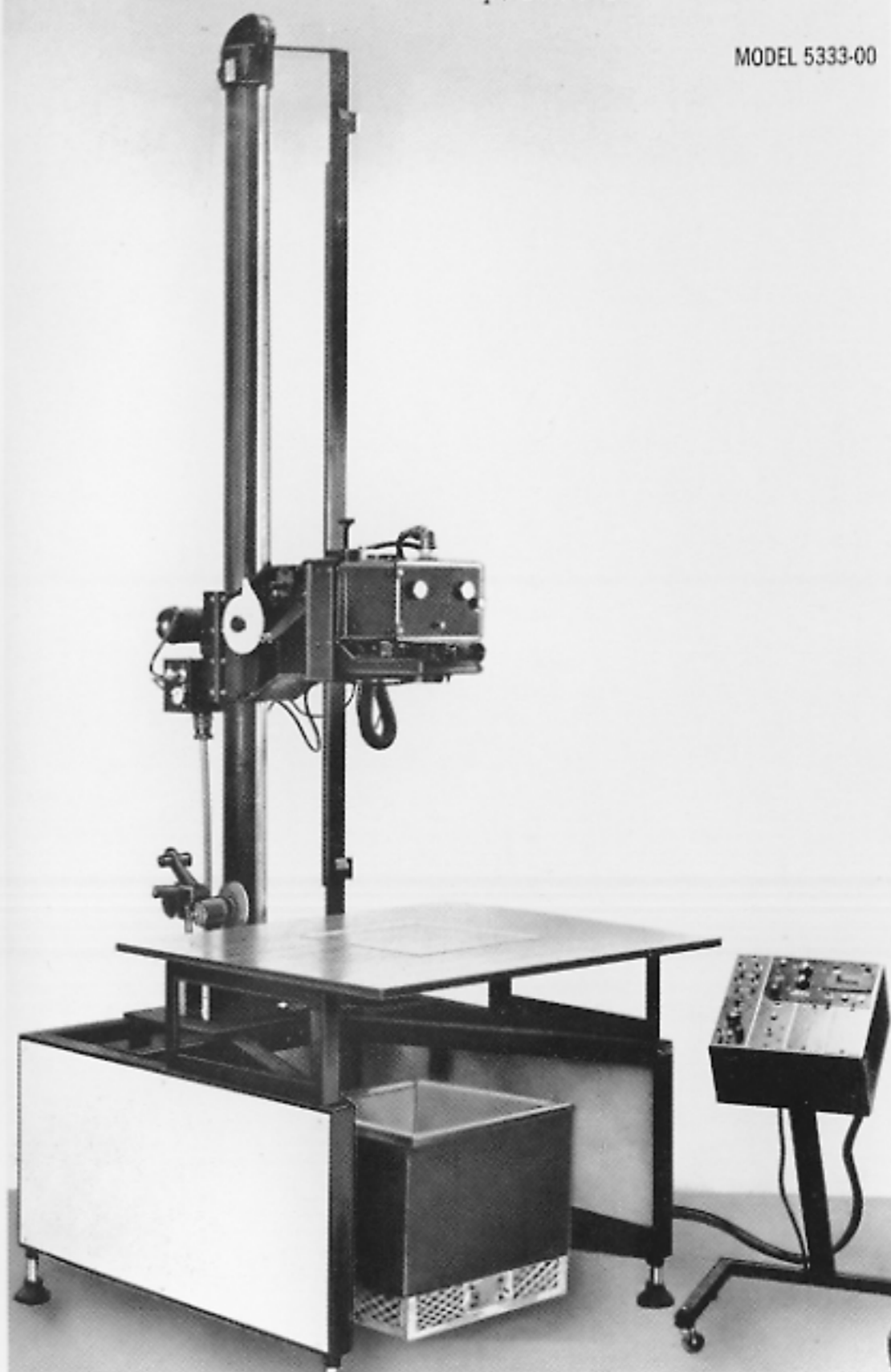

The 5326-01 16mm Animation Camera is interchangeable with the 5327-01 35mm Film/Strip Slide Camera on this stand. See section 6.0 of text.

OXBERRY



Typical installation of Model 5332-00 16mm Animation Stand and Camera with optional Rollaway Unit and Underlighting Unit. Photo courtesy of AMERICAN AIRLINES audio-visual department.