

For Instructional Purposes Only

**Canon**

# SCOOPIC 16M



Cal State LA Television, Film & Media Studies

6151 State University Drive, Los Angeles, CA 90032

**Canon Scoopic 16M INSTRUCTIONS**

[www.calstatela.edu](http://www.calstatela.edu)



Your new Canon Scoopic 16M camera is an updated and refined version of the Canon Scoopic 16, America's best selling automatic hand camera for television news and documentary filmmaking. Improved in many areas and offering more features than the standard Scoopic 16, the 16M will give you professional results everytime out simply, quickly and efficiently.

To obtain the best possible results and the most satisfaction from your new Scoopic 16M camera, close attention should be paid to each and every page of this instruction book prior to shooting your first roll of film.

#### Canon Scoopic 16M Set

Scoopic 16M body . . . . .	1
Nickel-cadmium battery S-12 . . . . .	1
75mm lens cap . . . . .	1
72mm lens hood . . . . .	1
Battery charger S-12 . . . . .	1
Case . . . . .	1

#### Accessories

Close-up lenses	
External battery box	
Filters	
86mm hood (for series No.9 filters)	
CdS window compensating ND filter	

## Location of Parts and Controls

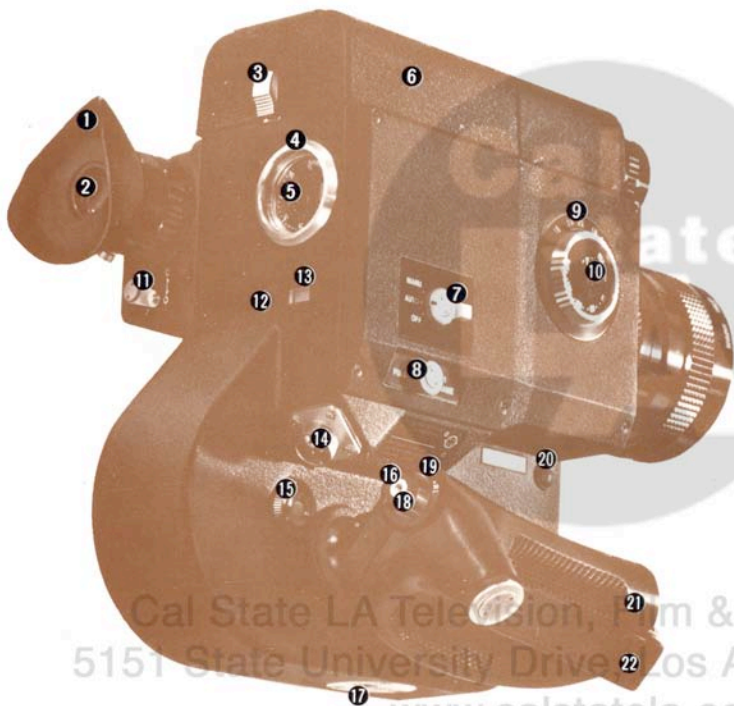

1. Eyecup
2. Finder eyepiece
3. Battery chamber lock button
4. Frame counter
5. Footage counter
6. Battery chamber
7. Power supply switch
8. Single frame shot knob  
changeover knob
9. Filming speed selector
10. Film speed dial
11. Finder shutter lever
12. Battery checker button
13. Battery checker
14. External power supply connector
15. Film feed indicator
16. Release socket
17. Tripod socket
18. Shutter button
19. Running lock scale
20. Aperture opening button
21. Handgrip
22. Handstrap

## For Instructional Purposes Only

23. Zoom lens
24. Macro ring lock release knob
25. Manual aperture control ring
26. CdS window
27. Manual aperture setting scale (T value)
28. Accessory shoe
29. Eyepiece adjusting ring
30. Eyepiece adjusting ring setscrew
31. Focus ring
32. Handstrap fastener
33. Zoom lever
34. Zoom ring
35. Macro ring
36. Side cover lock button
37. Side cover knob
38. Film position mark

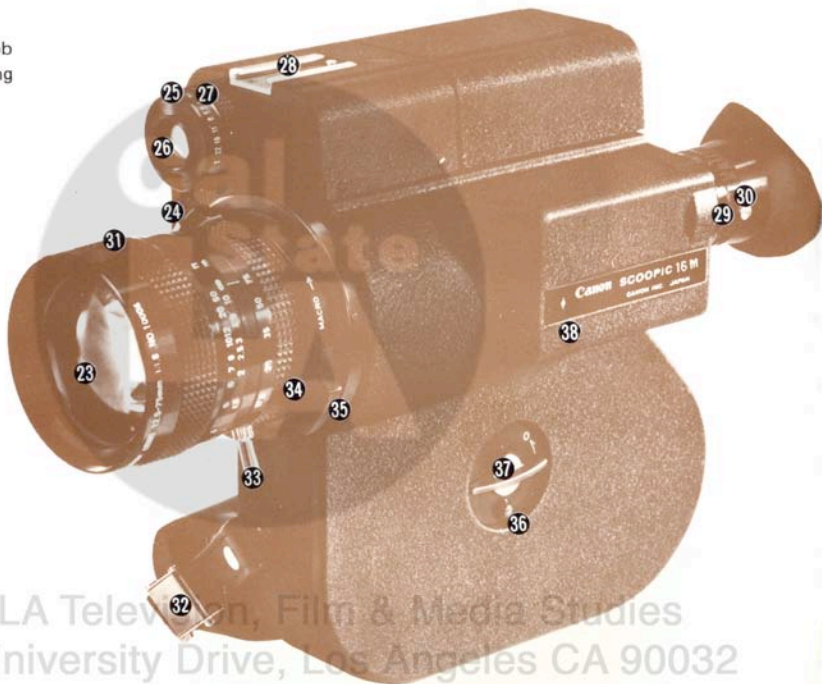

Cal State LA Television, Film & Media Studies  
5151 State University Drive, Los Angeles CA 90032  
[www.calstatela.edu](http://www.calstatela.edu)

# Main Features

## ● World's First 16mm Movie Camera Incorporating Zoom Lens with Macro Mechanism

The Scoopic 16M is the world's first 16mm movie camera having a built-in zoom lens with macro mechanism. The zoom lens has a focal length of 12.5 to 75mm ( $1\frac{1}{2}$ "— 3"), a zoom ratio of 6:1. The lens T number is a fast T2.5 (F1.8).

T-stop means how much of the light entering the front actually reaches the film plane. Since some light is diverted both to CdS window for EE mechanism and to viewfinder, the eventual T/stop comes to T2.5 in case of 12.5—75mm F1.8 built in this camera.

## ● CdS Electric Eye Mechanism

Shooting with accurate exposure is always assured by the built-in automatic aperture mechanism coupled to the electric eye circuit using a supersensitive CdS cell. The finder features an exposure meter indicating needle. Provision is made for either fully automatic or manual electric eye metering.

## ● Powerful NiCd Battery

The film drive motor and EE circuit operate on a rechargeable Canon NiCd battery. It can be recharged more than 100 times. One charge allows shooting for about sixteen 100-foot spools at 24 fps. It is fully recharged in 3.5 hours with the exclusive battery charger.

## ● Automatic Film Loading

This mechanism provides for easy film handling and eliminates misloading. Insert the film leader in the guide, press the shutter button and the film will automatically thread.

## ● Single-lens Reflex Finder

Through-the-lens reflex viewing assures perfect, parallax-free subject composition.



# Specifications

**Type:** EE 16mm movie camera with built-in zoom lens with macro mechanism.

**Film:** 100 feet (30.5 meters) of 16mm single or double perforated film.

**Lnes:** Focal length: 12.5 – 75mm ( $1/2''$  –  $3''$ )

Zoom ratio: 6:1

T number (F number): T2.5 (F1.8).

Construction: 16 elements in 12 components.

Front thread: 72mm ( $2\ 13/16''$ ), P 0.75.

Outer diameter: 75mm ( $3''$ ).

Focus range: 1.1m ( $3\ 7\ 5/16''$ ) to infinity.

Macro control range: 80 – 750mm ( $3\ 1/8''$  –  $2\ 5\ 1/2''$ ).  
(from the front vertex to focal plane).

Multipoint focusing is possible.

**Exposure System:** EE automatic aperture mechanism coupled to built-in CdS photocell and micromotor-driven servo mechanism. Manual aperture control is also possible.

**EE Operating Range:** Entire range of ASA 640, T2.5, 16 fps. to ASA 20, T22, 64 fps. (single frame shooting is not coupled).

**Film Speed Indexes:** ASA 20 (25 32) 40 (50 64) 80 (100 125) 160 (200 250) 320 (400 500) 640.

**Filming speeds:** Single frame, 16, 24, 32, 48 and 64 fps.

Shutter opening angle: 170 degrees.

**Manual Aperture Control:** Ordinary shooting is possible at any T/stop.

**Film Drive System:** By a built-in micromotor controlled by electronic governor.

**Power Supply:** Film drive and automatic aperture control by a built-in exclusive 12 V NiCd battery. An external battery may be also used.

**Film Loading:** Automatic. Just insert the film tip into the guide.

**Zoom:** Manual rotation of lens barrel.

**Viewfinder:** Single-lens reflex type. TV frame line, T/stop scale, over-exposure and under-exposure warning marks and meter needle are displayed. Visibility is controllable from  $-4$  to  $+2$  diopters. A shutter is incorporated to prevent incidence of light.

**Footage Counter:** Adding type which can be reset to S position by opening the side cover. Frame counter with 40 frames (1 foot) in one rotation.

**Other:** Film takeup knob, accessory shoe, battery checker, shutter running lock.

**Size:**  $287 \times 230 \times 162$ mm ( $11\ 5/16'' \times 9\ 1/16'' \times 6''$ )

**Weight:** 3.3 kg (7.3 lbs.)

## Battery and Battery Charger

The Scoopic 16M uses a 12 V NiCd battery for driving film and operating the electric eye circuit.

The battery is shipped uncharged; therefore, charge it before use. One battery permits shooting of sixteen 100-foot rolls at 24 fps.

The Canon Battery Charger S-12 can charge two batteries at the same time.

### • Canon Battery Charger S-12

**Voltage:** 50/60 Hz, AC100–240V

**Charging Time:** 3.5 hours at a normal temperature of 20–25°C for a battery whose power level is found to be within the red region on the battery checker.

**Charging Circuit:** An electronic cut-off circuit prevents overcharging of Scoopic batteries. It also prevents accidental discharge of battery should a power failure occur during charging.

**Recharging:** Batteries may be recharged in proportion to film used. A battery on which eight rolls of film have been exposed may be recharged in approximately 2 hours.



# For Instructional Purposes Only

## • Charging Battery

The pilot lamp goes on when the charger is plugged into the power supply.

Insert the battery into the charger.

A weakening glow of the pilot lamp indicates a full charge.

Two batteries can be charged at the same time.

Recharge the battery if it has been left unused for over one month. Have a spare battery ready when many pictures are to be taken.

## • Setting Voltage

In charging the battery, set the voltage selector to the voltage to be used.

Remove the fuse. Pull off the selector, set the selector, display the voltage and reinstall the fuse.

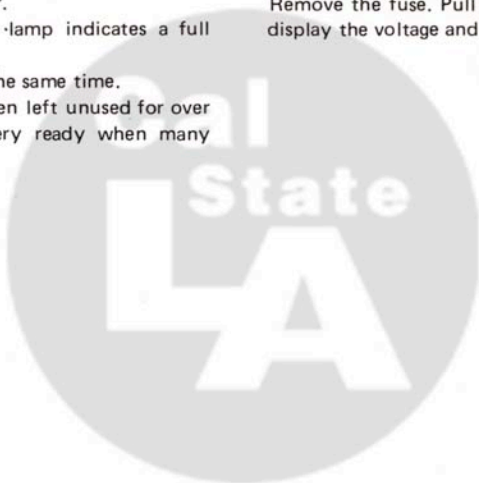

Cal State LA Television, Film & Media Studies  
5151 State University Drive, Los Angeles CA 90032  
[www.calstatela.edu](http://www.calstatela.edu)



## Precautions for Battery Handling

1. Charge the battery at an ambient temperature of  $10^{\circ}\text{C}$  or over; charging at  $0^{\circ}\text{C}$  or less may damage the battery.
2. Making contact between the positive and negative terminals of your Scoopic battery may cause a high speed discharge and possible damage to the battery. Never store a spare battery in a pocket along with other metal objects such as keys.
3. If the battery is left unused for a long period of time, load it in the camera, operate the camera for a few minutes to discharge it.
4. The battery can be recharged more than 100 times under normal use. Replace battery when a full charge will only provide power for half the amount of film as a new battery.
5. All NiCd batteries can potentially explode if exposed to extreme heat such as fire. **NEVER INCINERATE A USED BATTERY.**



Cal State LA Television, Film & Media Studies  
5151 State University Drive, Los Angeles CA 90032  
[www.calstatela.edu](http://www.calstatela.edu)

## Loading Battery

1. Push up the lock button of the battery chamber and pull the cover open.
2. Load the battery.

Take the battery out of the camera if it is not to be used for an extended period of time.

## Checking Battery

Check the battery power level regularly.

1. Push the battery check button and evaluate the power level according to the position of the needle in the battery check window.
2. Recharge the battery when the needle stays within the red region.

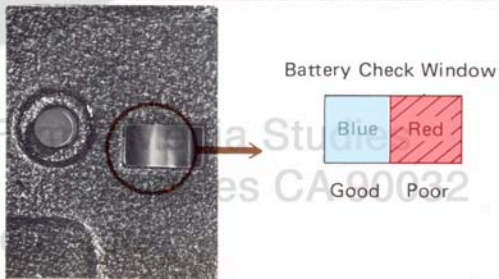

## Adjusting Finder Eyepiece

1. Be sure the finder shutter lever is in 0 position.
2. Loosen the eyepiece setscrew, direct the camera at a bright subject and look into the camera.
3. Place the EE changeover lever to MANU, turn the manual aperture ring and set the meter needle at T2.5.

4. Turn the eyepiece adjusting ring clockwise and counterclockwise until grains are distinctly observed. Then fix the eyepiece with the setscrew. Without this adjustment, proper focusing is impossible. The range of the adjustment is  $-4$  to  $+2$  diopters.



## Setting Film Speed

The EE mechanism of the Scoopic 16M is coupled to both the filming speed (frame rate) selector and the film speed (ASA) selector of the camera. The correct ASA of the film is determined by referring to the manufacturers specifications supplied with the film.

(Refer to pages 33 and 34 for ASA filter factor adjustments.)

Scoopic 16M ASA Scale:

ASA 20 (25 32) 40 (50 64) 80 (100 125) 160 (200 250)  
320 (400 500) 640

Figures in parentheses indicated by dots on ASA scale.

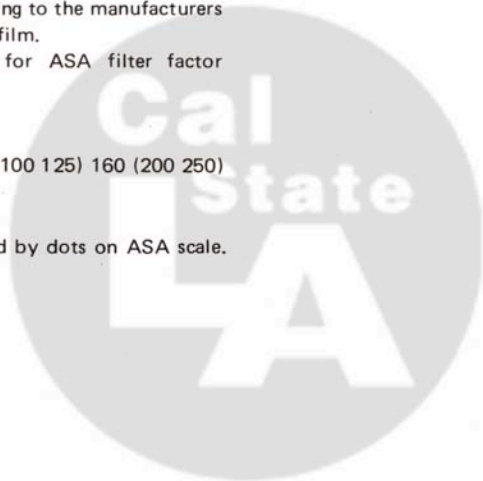

## Setting Filming Speed

The filming speed selector sets the number of frames to be fed per second. 24 frames is standard for 16mm movie cameras. Turn the dial and set the desired filming speed to the index.

Since the film hardens at a temperature of 0°C or lower, the number of frames may be reduced at 48 or 64 fps. The use of a coldproof case and external battery is recommended.

The relations between frames per second and exposure time at a shutter opening of 170° are as follows:

Frames per second	16	24	32	48	64
Exposure time(sec)	1/34	1/51	1/68	1/102	1/136

Filming speeds in between cannot be used.

Proper exposure of single frame shot is assured by setting at 16 fps or 24 fps. Its exposure time is  $\frac{1}{34}$  or  $\frac{1}{51}$ .

**Never use higher filming speeds when unloaded.**

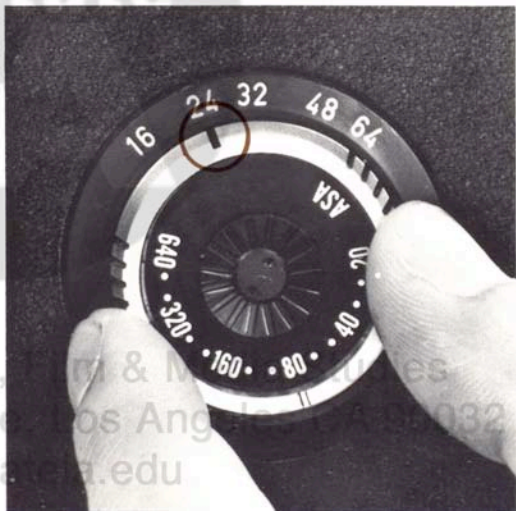



# Filming Speeds and Projection Effects

It is standard to shoot and project the film at 24 fps.

## High Speed Filming

Projection at 24 fps. of film photographed at a speed of 48 or 64 fps. produces a slow-motion effect. For example, when a film shot at 48 fps. is projected at a standard 24 fps., the projecting time will be doubled, thereby halving the speed of the action projected. High filming speed is effective for slowing the action of a fast-moving subject or analyzing movements. Exposure time is also speeded up and blurring during panning can be eliminated.

## Low Filming Speed

Shooting at 16 fps. gives the opposite effect. The reduced filming speed will bring a fast motion effect in the pictures projected at 24 fps. This method is helpful in stressing the action of a subject, bringing the projected action of a distant subject close to the actual action or creating a humorous effect. The slow speed is also used for overcoming under-exposure conditions 24 fps. even at maximum aperture opening.

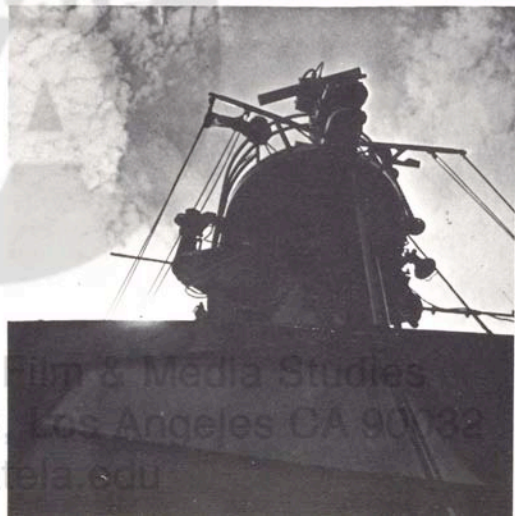

# For Instructional Purposes Only

## EE Changeover Lever

The 16 fps. must be used for controlling exposure by giving due considerations to change in speed of movement of a subject when projected.

Place this lever on AUTO and the EE circuit will be coupled to allow shooting with automatic aperture control. When it is turned to OFF, all circuits except for the battery checker are disconnected. Set the lever at MANU for introduction of special effects. See page 23.



## Holding Camera

Firmly grasp the handgrip with the right hand and depress the shutter button with the right thumb. Focusing, zooming and steadying of the camera are accomplished with the left hand. Hold the camera steady, particularly when shooting at a long focal length or zooming. The use of a tripod and cable release is recommended.



# For Instructional Purposes Only

## Adjusting Eyecup

The eyecup is revolvable. Adjust it to fit your eye. Do not move your eye away from the eyecup, otherwise, strong light may enter through the finder eyepiece thereby fogging the film. Use the finder shutter lever when taking your eye away from the eyecup. Placing the lever to C allows the shutter in the finder to drop and thus prevents incidence of light.

## Adjusting Handstrap

Open the handstrap buckle and adjust the length of the handstrap.



Television, Film & Media Studies  
University Drive, Los Angeles, CA 90032  
[www.calstatela.edu](http://www.calstatela.edu)



## Zooming

Turning the zoom ring changes the magnification of an image. The need for interchangeable lenses is eliminated and very effective expressions are assured.

The finder of the Scoopic 16M is of the single-lens reflex type in which the field-of-view and the picture frame are identical. Therefore, the pictures can be composed within the maximum field-of-view.

Use the zoom lever when turning the zoom ring.

## For Instructional Purposes Only

Relations between Focal Length and Field-of-view

Focal length (mm)	12.5 ( $1\frac{1}{2}$ "')	17.5 ( $1\frac{1}{16}$ "')	25 (1"')	35 ( $1\frac{3}{8}$ "')	50 (2"')	75 (3"')
Field-of-view	44.1° x 33.0°	32.7° x 24.2°	23.2° x 17.0°	16.7° x 12.2°	11.7° x 8.6°	7.9° x 5.8°





# For Instructional Purposes Only

- The focal point does not change by turning the zoom ring.
- When you wish to keep the subject always in the center of the picture while zooming, fix the camera in a stationary position, set the subject in the center of the viewfinder at the maximum focal length of 75mm (3"), and focus. Zooming can be performed from any desired focal length after that.

When you wish to zoom up on a subject and put it into the center of the viewfinder, set the focal length at 75mm (3"), position the subject in the center of the viewfinder, return it to the short focal length side, and then zoom up once more on the subject and shoot.

On the contrary, if the subject is positioned in the center with the focal length set on the short side, the slight aberration at that time will be expanded when the lens is zoomed up to form a zooming aberration.



$f = 12.5\text{mm}$   
( $1/2''$ )

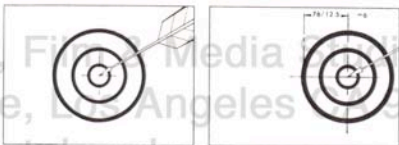

$f = 75\text{mm}$   
( $3''$ )

## Focusing

Turn the focus ring to obtain the sharpest image. The greater the focal length the more easily and accurately the aligned image can be seen. Zooming does not move the image out of focus. First focus at the maximum focal length of 75mm (3"), then return the lens to the desired magnification.

When the shutter button is depressed, the correct exposure for the subject being photographed will be indicated by the needle in the T/stop scale and the lens will "stop-down" to the correct T/stop. To temporarily

override this system and bring the aperture to a full open position for fast focusing, depress the aperture opening button and hold during focusing. Releasing the aperture opening button allows the diaphragm to return to the correct shooting aperture.

Adoption of the all-matted focusing screen allows focusing at any point in the viewfinder.



## Exposure Meter Needle and Exposure

The automatic exposure system of the Scoopic 16M is activated when the shutter release button is depressed approximately half way. The lens will then "stop-down" to the correct shooting aperture and this aperture will be indicated by the needle in the T/stop scale.

### AUTO Shooting

When the aperture setting needle is within the proper exposure range, press the shutter button all the way. The film will be fed and will be ready for shooting.

The needle within the right-hand red mark means over-exposure. Attach an ND filter to reduce the light intensity.

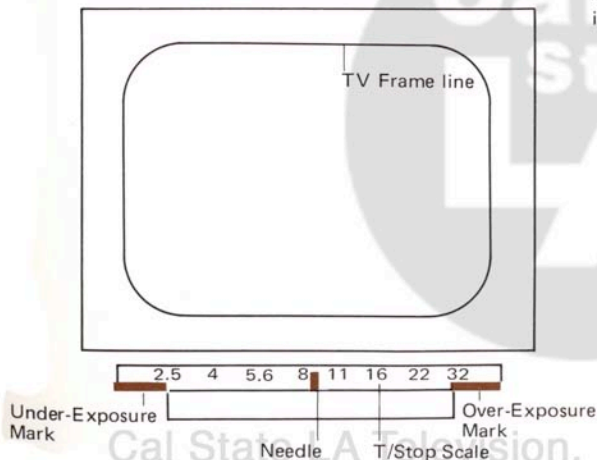

## Shutter Button

The needle within the left-hand red mark means under-exposure.

Depress the shutter button slightly at first, depress it all the way down after determining the T/stop.

- When the shutter button is pressed only slightly, the operating sound of the EE can be heard but the film will not advance.

- Place the EE changeover lever at OFF when the camera is not used. The battery cannot be consumed even if the lever is not switched to OFF. An inadvertent

depressing of the shutter button can be prevented with the EE changeover lever at OFF.

Turn the shutter button clockwise while depressing it all the way down, and it will remain depressed when you release your finger and continuous shooting will be possible. To end shooting, fully turn the shutter button counterclockwise and it will release.

A cable release socket is provided in the center of the shutter release button for remote operation.

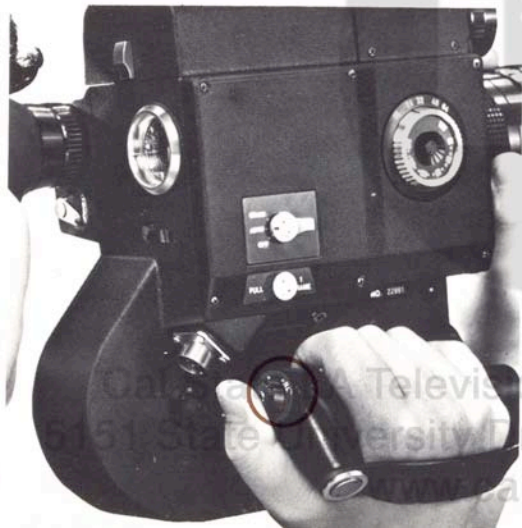

# Shooting with Manual Aperture Control

1. Place the EE changeover lever to MANU.
2. Set the manual aperture control ring to the desired T/stop or set the aperture needle within the finder to the desired T/stop.

Zooming and focusing are made in the same manner as in EE shooting.

Shooting with manual aperture control may be employed in the following cases:

- Shooting against light
- Obtaining special effects
- Panning at very high speed
- Shooting a subject whose brightness changes rapidly

## Note:

If you should want to make an exposure determination with a hand held meter instead of the built-in meter in the Scoopic 16M, you need only adjust the T/stop scale of the camera to the same number indicated by the f/stop scale of the meter. For example, if meter reads f4, set camera dial to T/4. Your exposures will always be perfect since all light loss factors have already been accounted for.





## Macro Filmmaking

A macro mechanism is built into the lens of your Scoopic 16M to film subjects at closer than the normal minimum focusing distance of 1.1 meters ( $3'7\frac{5}{16}''$ ). Turn the macro ring clockwise while depressing the lock button. When the focus ring is set at the close distance and the macro ring is fully turned clockwise, close-ups are possible to 80mm ( $3\frac{1}{8}''$ ) wide-angle and 750mm ( $2'5\frac{1}{2}''$ ) telephoto.



## Multi-point Focus Shooting

When the focal length is varied through zooming for macro shooting, the focus point changes correspondingly. Multi-point focusing utilizes this characteristic to give a special effect in which the focus point is moved. Mount the camera on a tripod, lock the macro ring, set the zoom ring to the telephoto end and focus. Then, set the zoom ring to the maximum wide-angle, set the macro ring for macro shooting and control it to focus the lens on the nearest subject. As a checking measure, set the zoom ring to the maximum telephoto with the macro ring left as it is and refocus the lens on the deepest subject. When the zoom lens is set to the maximum wide-angle and the camera is zoomed the focus point will move from the nearest subject to the deepest subject and diversified cuts will be assured.

## Single Frame Shooting For Instructional Purposes Only

Single frame shooting is available to shoot titles or to include such data as dates and cut numbers.

The EE operation cannot be employed in this case.

Place the EE changeover lever to MANU and pull the single frame shooting changeover knob.

Depress the changeover knob to its original position at the end of the shooting.

To continue single frame shooting, steady the picture frame using a tripod and release.

Proper exposure is assured by operating the EE mechanism at 16 fps., reading the T/stop, switching the lever to MANU and performing single frame shooting.

For single frame shooting at 0°C or less, keep the camera warm by the use of a coldproof case etc.



Cal State LA Television, Film & Media Studies  
5151 State University Drive, Los Angeles CA 90032  
[www.calstatela.edu](http://www.calstatela.edu)

# For Instructional Purposes Only

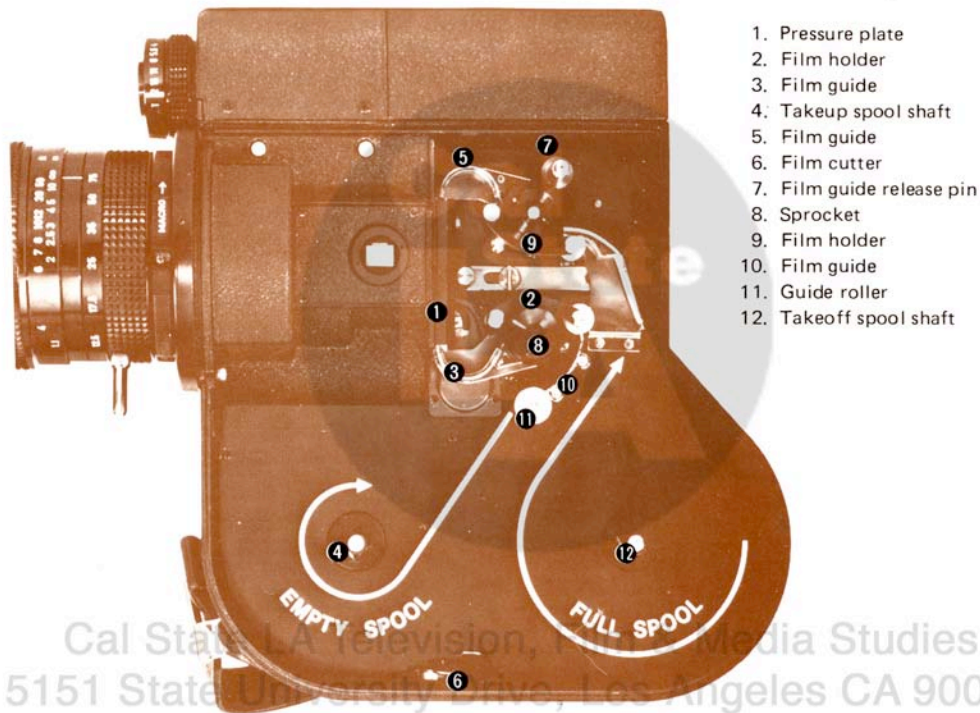

# For Instructional Purposes Only

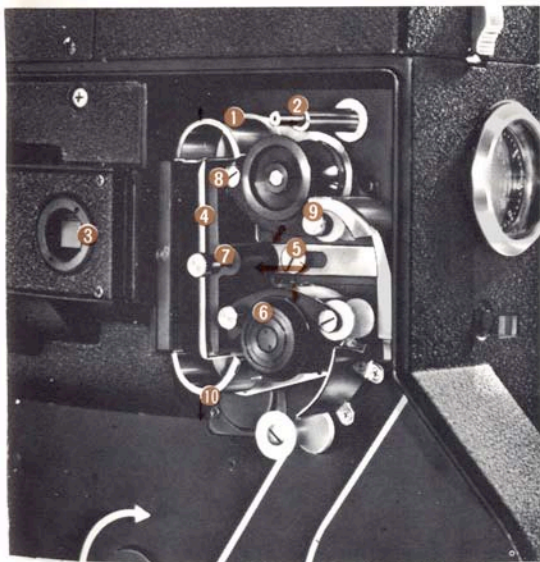

1. Film guide
2. Film guide release pin
3. Part of finder optical system
4. Pressure plate
5. Film holder
6. Film holder
7. Pressure plate release knob
8. Film holder
9. Film holder release knob
10. Film guide

## Releasing Each Part

The pressure plate can be opened by turning the setscrew for unloading the film or cleaning the aperture plate.

- Unless knobs for the pressure plate and film holders are properly dropped in, the film will not be properly loaded or the side cover will not be closed completely. Restore each part properly after cleaning.

# Loading Film For Instructional Purposes Only

Any standard 16mm, single or double perforated, 100-foot (30.5-meter) film can be used.

Film can be automatically loaded. Make a habit of loading film correctly because carelessness may race or fog the film.

## Avoid Direct Sunlight

The film is wound naked around the reel; always load the film in the shade. An extra length of leader is attached to the film for protection against the entry of light. But the film may be fogged by direct sunlight or strong lighting if it is loosely wound.

1. Depress the side cover lock button, turn the knob in the direction of the arrow and remove the side cover.
2. Insert the takeoff film spool on the shaft as indicated by the diagram inside the camera.

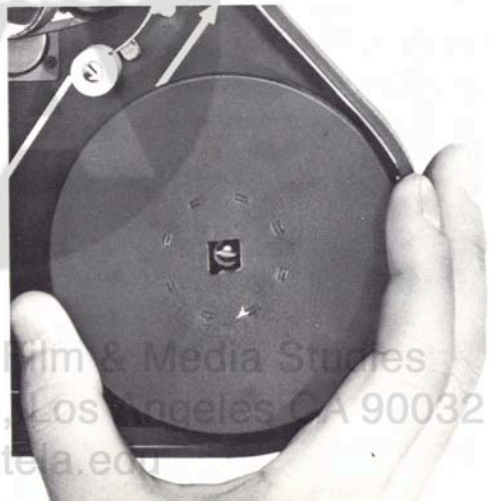



3. Cut off the tip of the film leader with the film cutter.

- Make the cutoff by matching a perforation and a positioning pin provided on the cutter.

4. Insert the tip of the leader into the insertion guide.

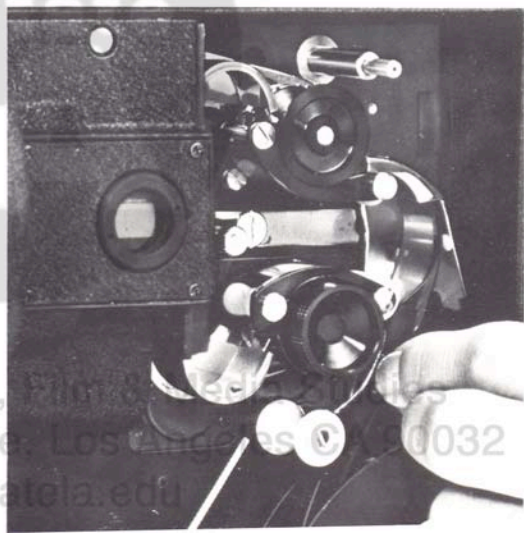
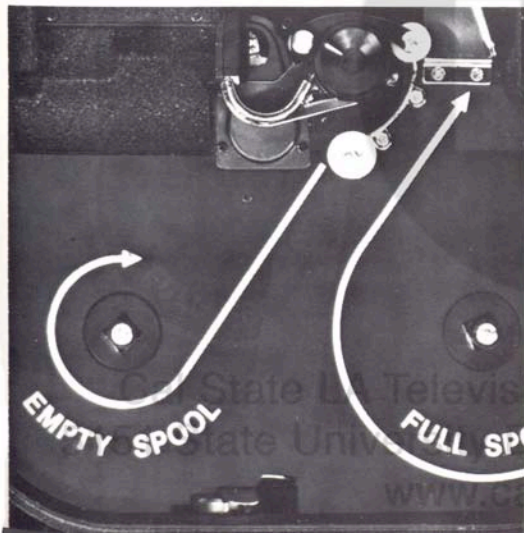

# For Instructional Purposes Only

5. Have the filming speed at 16 or 24 fps. Make sure the film holder on the side of the takeoff spool shaft is in the proper position. Push the film slightly while pressing the shutter button.

6. The film will automatically thread through the film guide and the aperture plate and come out of the bottom sprocket. Stop pressing the shutter button when some 30cm (11<sup>13</sup>/<sub>16</sub>" ) of the film leader has passed through the guide roller.

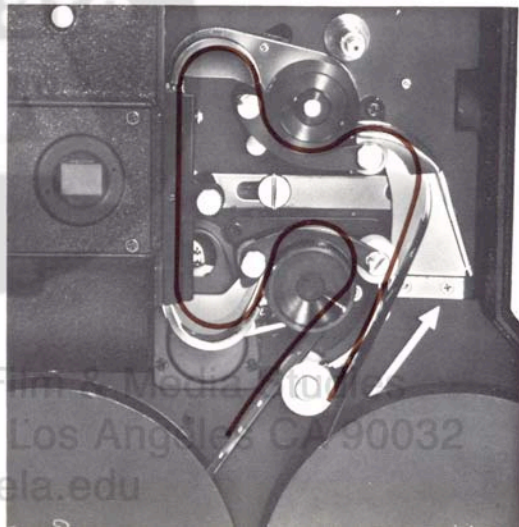
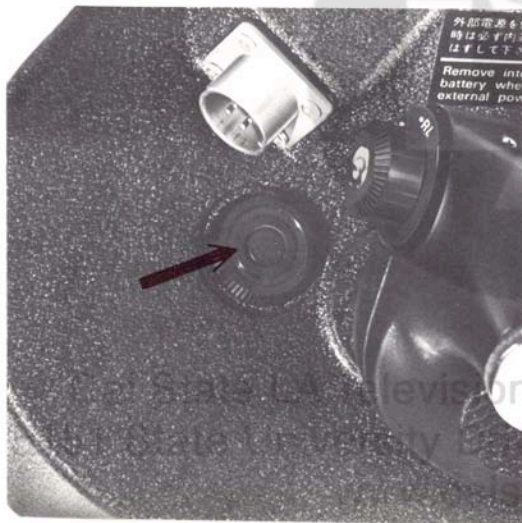

7. Have the takeup spool ready and check to see if its top is facing upwards.

Bend the tip of the film leader toward the emulsion-coated side and insert it in the takeup spool as indicated by the diagram. Wind the film leader tightly several times around the takeup spool.

8. Place the takeup spool on the shaft.

9. Press the shutter button while pressing the film guide release pin, and check the top and bottom film loops to be sure they are uniformly fed. A feed of 10 (3<sup>15</sup>/<sub>16</sub>"") to 15cm (5<sup>7</sup>/<sub>8</sub>"") is enough.

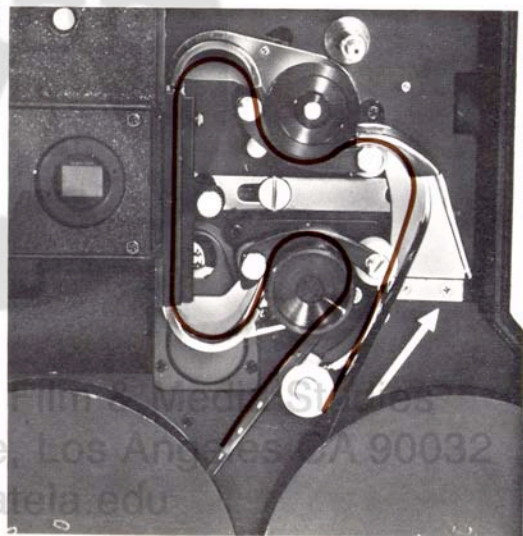
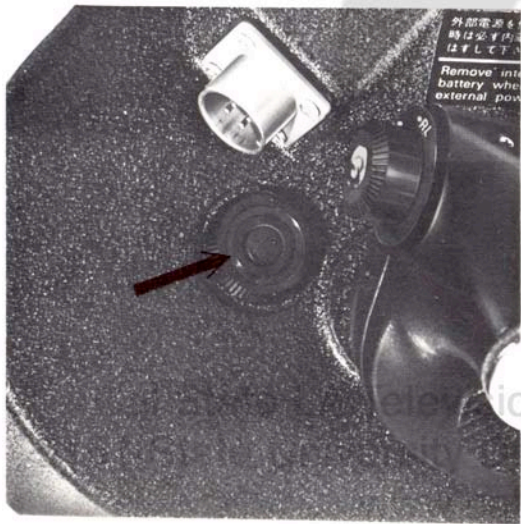

## For Instructional Purposes Only

# Footage Counter

10. Reinstall and relock the side cover.
11. Press the shutter button and feed the film until the footage counter advances from S to 0. Start shooting from 0 position.

Make sure the film feed indicator is rotating. This indicator corrects a slackened film and checks to see the film is properly fed. The slackness can be removed by turning the indicator counterclockwise.

As shooting proceeds, the frame counter of the footage counter indicates the length of exposed film.

The footage counter is marked every five feet from 0 and numbered every 20 feet. The portions between S and 0 and between 100 and F both indicate the feed of film leader. Opening the side cover automatically resets the needle to S.



Cal State LA Television, Film & Media Studies  
5151 State University Drive, Los Angeles CA 90032  
[www.calstatela.edu](http://www.calstatela.edu)



## Unloading Film

Stop shooting when the counter reaches 100, feed the film to F and unload the takeup spool in the shade. Put the film in a container and send it to a laboratory.

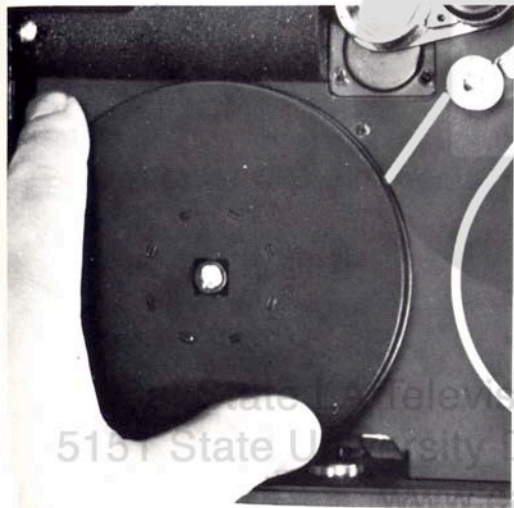

## Filters and Exposure Compensation

### Filters

72mm Screw-in type and Series No.9 filters are available. When using a filter, exposure time must be increased by the exposure factor of the filter.

### Canon Filters

(72mm Screw-in Type and Series No. 9)

Type	Exposure factor	Amount of adjustment (step)
UV (SL 39.3C)	1	
*Y1 (SY 44.2C)	1.5	1/2
Y3 (SY 50.2C)	2	1
R1 (SR 60.2C)	6	2 1/2
CCA12(Color Conversion A)	2	1
CCA 8	2	1
CCA 4	1.5	1/2
CCB12(Color Conversion B)	3	1 1/2
CCB 8	2	1
CCB 4	1.5	1/2
SKY (Skylight)	1	
ND 4	4	2
ND 8	8	3

\* For screw-in type only



# For Instructional Purposes Only

## Adjustment 1

### Changing ASA Index

Divide the ASA index of the film by the exposure factor of the filter. Set the film speed dial to this figure.

For example, a Y3 (exposure factor 3) filter is used for an ASA 100 film, the compensated ASA index is  $100 \div 2 = 50$ . Reset the film speed dial to ASA 50.

## Adjustment 2

### Adjusting T/stop

Adjust the T/stop by turning the aperture control ring according to the exposure factor of the filter. The T/stops are graduated in a multiple proportion. Increase the T/stop by 1 graduation when using a filter with an exposure factor of 2 and by 2 graduations when using a filter of an exposure factor of 4.

## Adjustment 3

### Adjusting by Using ND Filter

Use an ND 4 or ND 8 filter when the subject is too bright. With the ND 4 filter, attach an EE compensating ND 4 filter onto the CdS window. In this case, the film speed dial setting need not be corrected. When the ND 8 filter is used, divide the ASA index of the film by a filter exposure factor of 8 and reset the film speed. Or attach an EE compensating ND 4 filter onto the CdS window and reset the film speed dial to the ASA index divided by 2.

## Using External Battery

A 12 V Canon NiCd battery is available for shooting at low temperatures. The performance of the external battery and hence stable shooting at a low temperature of 0°C or less are assured by keeping it warm by the body temperature of the user or by a pocket warmer. A power switch is provided for the external battery to turn ON/OFF power. This switch allows the use of the external battery as a remote control unit. Remove the battery in the camera when using the external battery.

Fit the plug of the external battery box into the socket on the camera and turn it clockwise.

Check the external batteries with the battery checker the same way as for the built-in battery.

Charge the external battery with the Canon Battery Charger S-12.



## Lens Hood For Instructional Purpose Only Accessory Shoe

Use a lens hood to cut out harmful light. There are two types of hood: one for filters of the screw-in type and the other for the Series No. 9 filters.

When lighting is needed, shooting have to be made by two persons or the camera have to be operated by one hand.

The Scoopic 16M has an accessory shoe. If a lighting fixture is mounted on a stand, the photographer can double as a lighter.



## 72mm Close-up Lenses

### Close-up Lens 2100

Distance scale m (inch)	1.1 (3'7 <sup>5</sup> / <sub>16</sub> " )	∞
Film plane-to-subject distance m (inch)	0.83 (2'8 <sup>11</sup> / <sub>16</sub> " )	2.29 (7'6 <sup>3</sup> / <sub>16</sub> " )
Focal length mm (inch)	Picture area cm (inch)	
12.5 (1/2" )	48.4x35.3 (1'7 <sup>1</sup> / <sub>16</sub> " x1'1 <sup>7</sup> / <sub>8</sub> " )	170x124 (5'6 <sup>15</sup> / <sub>16</sub> " x4'1 <sup>3</sup> / <sub>16</sub> " )
17.5 (1 <sup>1</sup> / <sub>16</sub> " )	35.0x25.5 (1'1 <sup>7</sup> / <sub>8</sub> " x10" )	123x89.6 (4'7 <sup>7</sup> / <sub>16</sub> " x2' 11 <sup>1</sup> / <sub>4</sub> " )
25 (1" )	24.6x18.0 (9 <sup>5</sup> / <sub>8</sub> " x 7 <sup>1</sup> / <sub>16</sub> " )	86.3x63.0 (2'10" x2' <sup>13</sup> / <sub>16</sub> " )
35 (1 <sup>3</sup> / <sub>8</sub> " )	16.7x12.2 (6 <sup>9</sup> / <sub>16</sub> " x4 <sup>13</sup> / <sub>16</sub> " )	58.6x42.8 (1'11 <sup>1</sup> / <sub>16</sub> " x1'4 <sup>7</sup> / <sub>8</sub> " )
50 (2" )	12.3x9.0 (4 <sup>13</sup> / <sub>16</sub> " x3 <sup>9</sup> / <sub>16</sub> " )	43x31.4 (1'4 <sup>15</sup> / <sub>16</sub> " x1' <sup>3</sup> / <sub>8</sub> " )
75 (3" )	8.2x6.0 (3 <sup>1</sup> / <sub>4</sub> " x2 <sup>3</sup> / <sub>8</sub> " )	28.9x21.1 (11 <sup>3</sup> / <sub>8</sub> " x8 <sup>5</sup> / <sub>16</sub> " )

### Close-up Lens 1100

Distance scale m (inch)	1.1 (3'7 <sup>5</sup> / <sub>16</sub> " )	∞
Film Plane-to-subject distance m (inch)	0.69 (2'3 <sup>3</sup> / <sub>16</sub> " )	1.28 (4'2 <sup>3</sup> / <sub>8</sub> " )
Focal distance mm (inch)	Picture area cm (inch)	
12.5 (1/2" )	37.9x27.7 (1'2 <sup>15</sup> / <sub>16</sub> " x 10 <sup>7</sup> / <sub>8</sub> " )	88.6x64.7 (2'10 <sup>7</sup> / <sub>8</sub> " x2'1 <sup>1</sup> / <sub>2</sub> " )
17.5 (1 <sup>1</sup> / <sub>16</sub> " )	27.4x20.0 (10 <sup>13</sup> / <sub>16</sub> " x7 <sup>7</sup> / <sub>8</sub> " )	64.1x46.8 (2'1 <sup>1</sup> / <sub>4</sub> " x1'6 <sup>7</sup> / <sub>16</sub> " )
25 (1" )	19.3x14.1 (7 <sup>5</sup> / <sub>8</sub> " x5 <sup>9</sup> / <sub>16</sub> " )	45.1x32.9 (1'5 <sup>3</sup> / <sub>4</sub> " x1' <sup>15</sup> / <sub>16</sub> " )
35 (1 <sup>3</sup> / <sub>8</sub> " )	13.1x9.6 (5 <sup>3</sup> / <sub>16</sub> " x3 <sup>3</sup> / <sub>4</sub> " )	30.6x22.4 (1'1 <sup>1</sup> / <sub>16</sub> " x8 <sup>13</sup> / <sub>16</sub> " )
50 (2" )	9.6x7.0 (3 <sup>3</sup> / <sub>4</sub> " x2 <sup>3</sup> / <sub>4</sub> " )	22.5x16.4 (8 <sup>13</sup> / <sub>16</sub> " x6 <sup>7</sup> / <sub>16</sub> " )
75 (3" )	6.5x4.7 (2 <sup>9</sup> / <sub>16</sub> " x1 <sup>7</sup> / <sub>8</sub> " )	15.1x11.0 (5 <sup>15</sup> / <sub>16</sub> " x4 <sup>5</sup> / <sub>16</sub> " )

# For Instructional Purposes Only

## Close-up Lens 2100 + 1100

Distance scale m (inch)	1.1 (3'7 <sup>5</sup> / <sub>16</sub> "')	∞
Film plane-to-subject distance m (inch)	0.60 (1' 11 <sup>5</sup> / <sub>8</sub> "')	0.93 (3' <sup>5</sup> / <sub>8</sub> "')
Focal length mm (inch)	Picture area cm (inch)	
12.5 (1/2"')	31.0x22.6 (1' <sup>3</sup> / <sub>16</sub> "'x8 <sup>7</sup> / <sub>8</sub> "')	59.2x43.2 (1'11 <sup>5</sup> / <sub>16</sub> "'x1'5"')
17.5 (1 <sup>1</sup> / <sub>16</sub> "')	22.4x16.4 (8 <sup>13</sup> / <sub>16</sub> "'x6 <sup>7</sup> / <sub>16</sub> "')	42.8x31.3 (1'4 <sup>7</sup> / <sub>8</sub> "'x1' <sup>5</sup> / <sub>16</sub> "')
25 (1"')	15.8x11.5 (6 <sup>1</sup> / <sub>4</sub> "'x4 <sup>1</sup> / <sub>2</sub> "')	30.1x22.0 (11 <sup>7</sup> / <sub>8</sub> "'x8 <sup>11</sup> / <sub>16</sub> "')
35 (1 <sup>3</sup> / <sub>8</sub> "')	10.7x7.8 (4 <sup>3</sup> / <sub>16</sub> "'x3 <sup>1</sup> / <sub>16</sub> "')	20.5x14.9 (8 <sup>1</sup> / <sub>16</sub> "'x5 <sup>7</sup> / <sub>8</sub> "')
50 (2"')	7.9x5.7 (3 <sup>1</sup> / <sub>8</sub> "'x2 <sup>1</sup> / <sub>4</sub> "')	15.0x11.0 (5 <sup>7</sup> / <sub>8</sub> "'x4 <sup>5</sup> / <sub>16</sub> "')
75 (3"')	5.3x3.9 (2 <sup>1</sup> / <sub>16</sub> "'x1 <sup>9</sup> / <sub>16</sub> "')	10.1x7.4 (4"x2 <sup>15</sup> / <sub>16</sub> "')

## Notes

- Check the battery before use.
- Charge the battery if its capacity is inadequate.
- Have a spare battery ready when many film spools are to be photographed.
- Place the changeover lever to OFF when shooting is ended.

### Cleaning Aperture Section

Always keep the aperture section clean. Film dust and grit are liable to accumulate in the aperture section. If left unremoved, these dust and grit may damage or soil subsequent reels of film. Remove them with a soft brush every time new film is loaded. When film is adhered tightly, remove it with something like a toothpick.

Do not use anything hard.



For Instructional Purposes Only

**Canon**

**CANON INC.** 9-9, Ginza 5-chome, Chuo-ku, Tokyo 104, Japan

U.S.A.

**NEW YORK** — **CANON U.S.A., INC.**  
10 Nevada Drive, Lake Success, Long Island, N.Y. 11040, U.S.A.

**MANHATTAN** — **CANON U.S.A., INC.**  
600 Third Avenue, New York, N.Y. 10016, U.S.A.

**CHICAGO** — **CANON U.S.A., INC.**  
457 Fullerton Avenue, Elmhurst, Illinois 60126, U.S.A.

**LOS ANGELES** — **CANON OPTICS & BUSINESS MACHINES CO., INC.**  
3113 Wilshire Blvd., Los Angeles, California 90010, U.S.A.

CANADA

**TORONTO** — **CANON OPTICS & BUSINESS MACHINES CANADA LTD.**  
3245 American Drive, Mississauga, Ontario, Canada

EUROPE, AFRICA  
& MIDDLE EAST

**AMSTERDAM** — **CANON AMSTERDAM N.V.**  
Gebouw 70, Schiphol Oost, Holland

CENTRAL &  
SOUTH AMERICA

**PANAMA** — **CANON LATIN AMERICA, INC.**  
Apartado 7022, Panamá 5, República de Panamá

Cal State LA Television, Film & Media Studies

5151 State University Blvd., Los Angeles, CA 90032