



Canon
514XL-S
CANOSOUND

E

INSTRUCTIONS



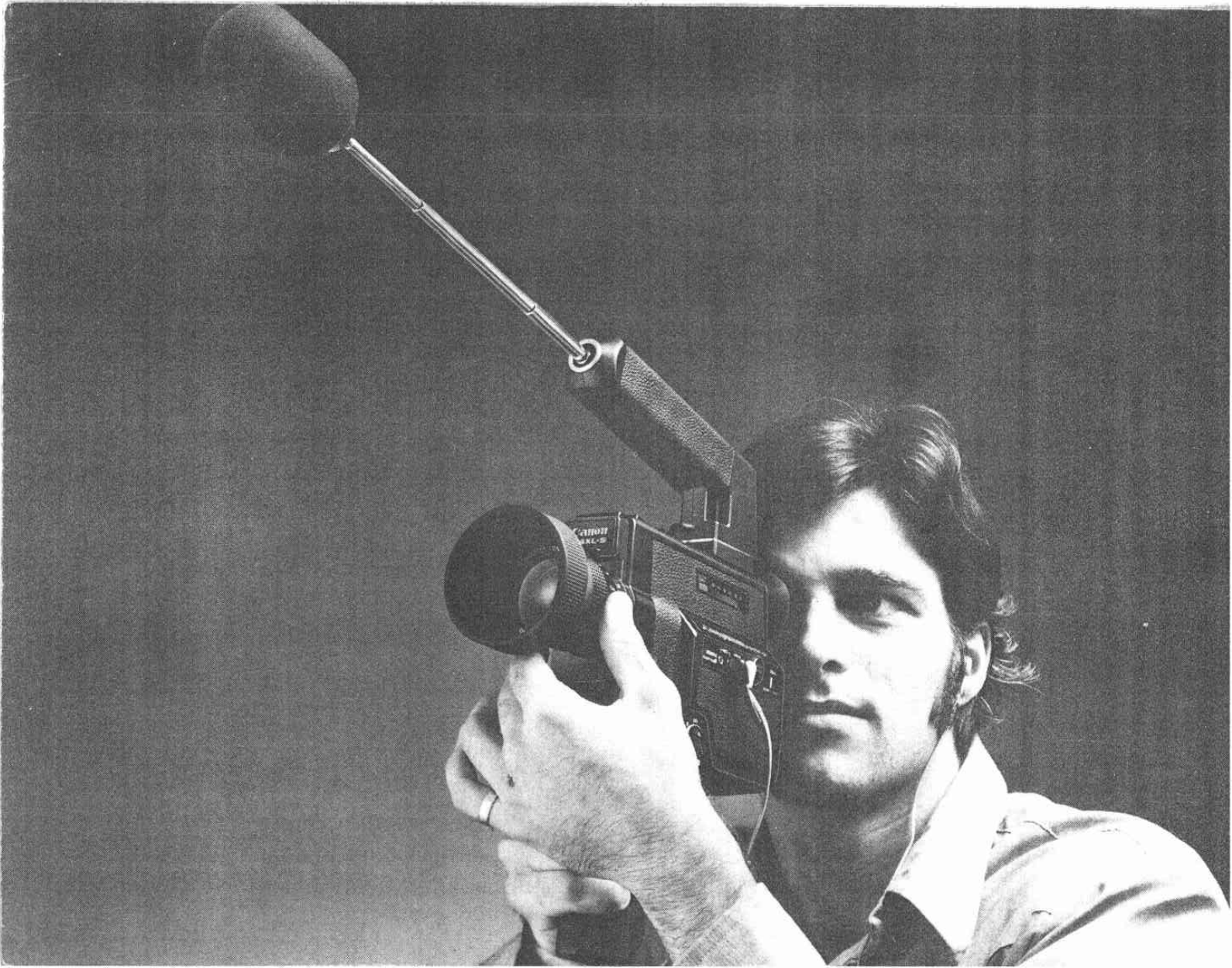

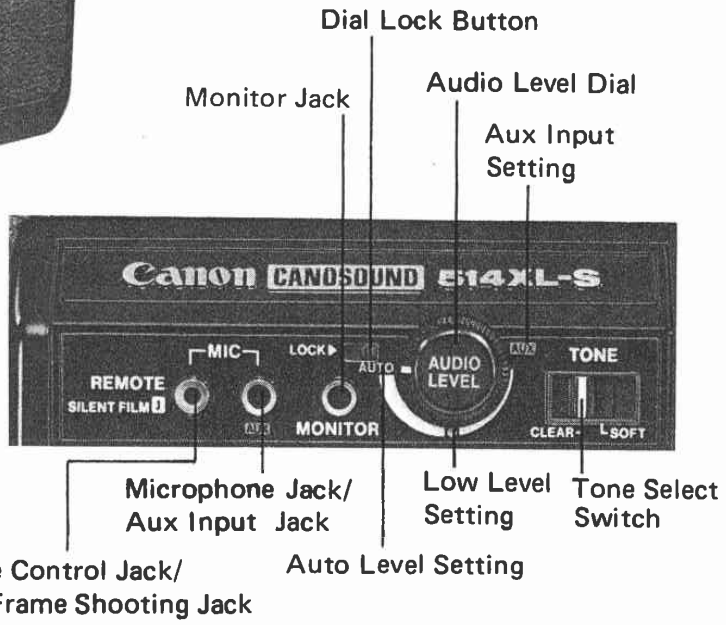
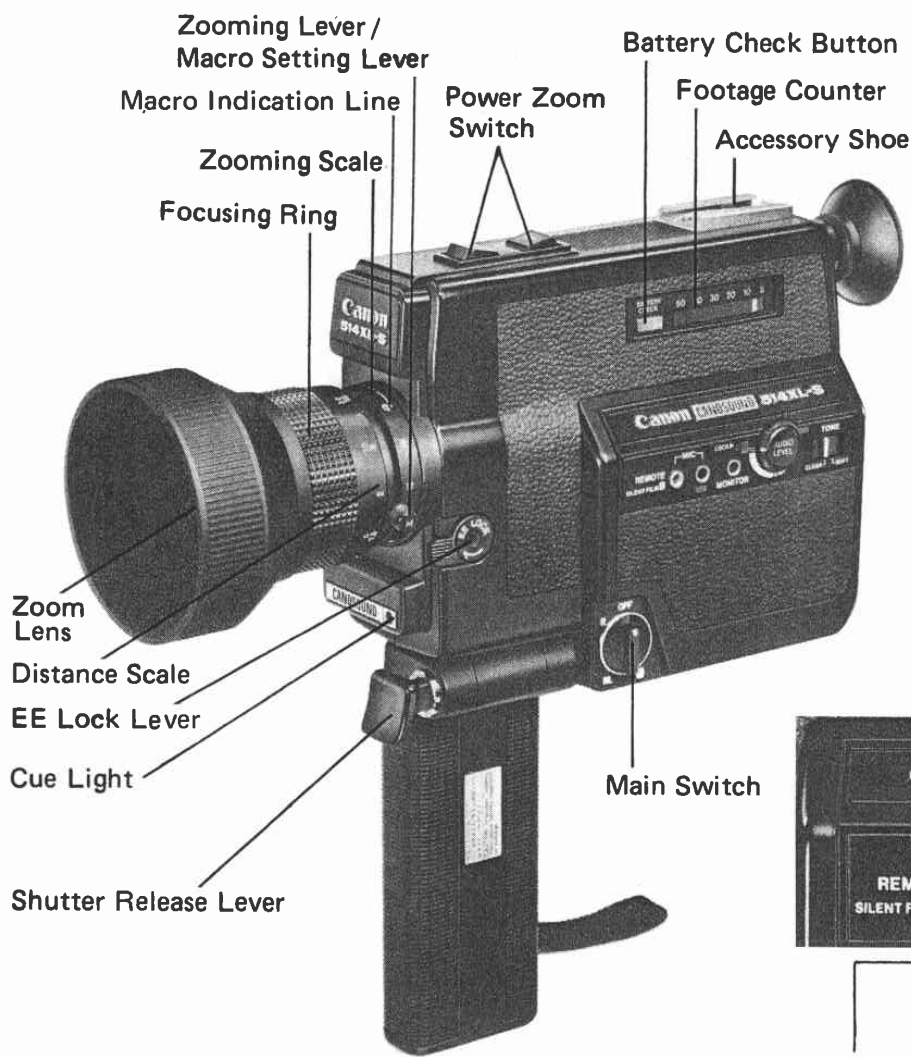

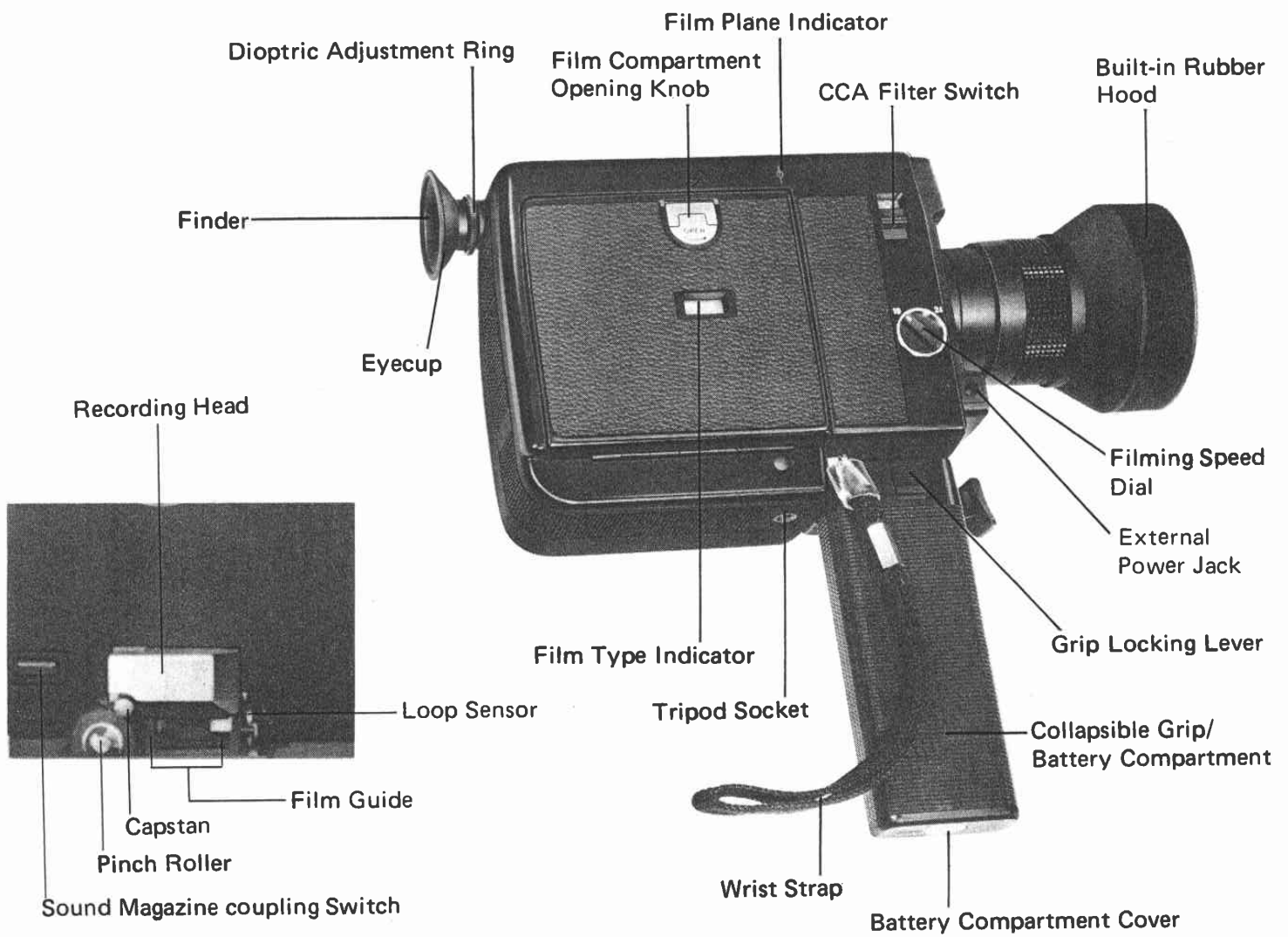

This Super 8 movie camera makes use of the latest electronic technology for completely reliable sound and silent filming. The Canon 514XL-S was designed with the compactness and maneuverability of silent movie cameras, maintaining all their excellent features such as a high precision zoom lens, macrocinematography option, and the XL system for filming in dim light, plus the most excellent features of sound movie cameras to enable all users, amateur or expert, to make sound films of the highest quality.

Outstanding Features:

- **Canon's Unique ALC Circuit**

The volume level is controlled by an Automatic Level Control (ALC), which automatically sets the right recording volume according to volume and duration of the sound. This is very effective in returning to the correct sound level from a loud sound or sudden noise, and enables effective sound recording. This recording system gives human voice and instrument sound precedence and represents sound perspective exceptionally

well. There are two settings in ALC, one is for normal recording and the other is for recording high volume sound without distortion (e.g. the sound of jet planes or trains) or use of the mike near the subject's mouth with loud background noise. Sound fading over a continuously adjustable range is also possible.

- **Three-Way Audio Level Dial**

This dial operates the two settings of ALC, fading by continuous control and auxiliary input.

- **Special Tone Select Switch**

It is possible to adjust the frequency characteristic by this switch in order to attain clear sound recording. It is very effective to eliminate low frequencies for 1. diminishing wind noise, 2. compensating the close-up effect of a microphone used near subject's mouth, 3. preventing spurious noise. (low frequency sound such as the noise of a fan).

- **Microphone with remote control switch**
- **Sound monitoring is possible by releasing the shutter lever at the first step.**

Other Features

- * Aux. input from other sound systems such as TV, radio and tape recorder.
- * Boom Microphone can be connected.

- **Lightweight and Compact**

Even with all the features the Canon 514XL-S has, it is still very lightweight and compact. The controls are located on one side of the camera for easy operation, and the grip is collapsible for compactness and carrying ease.

- **5X Zoom with Wide Angle and Telephoto Macrocinematography Mechanism**

With the 514XL-S macrocinematography is possible in both wide angle and telephoto with this large aperture zoom lens which allows great versatility. The focal length is from 9 to 45mm, and the large aperture f/1.4 lens is effective for close-up filming and in dim light conditions. The telephoto macrocinematography setting allows a full image field of 44 x 61mm.

- **XL Indoor Filming**

Because of the 514XL-S's shutter opening

angle of 220° and its fast lens and wide metering range, it has effective filming performance in the dimmest lighting conditions. The bright and accurate viewfinder also means accurate focusing in poor lighting situations.

- **The Viewfinder Contains All Filming Information**

All necessary information for filming is displayed in the viewfinder, including battery check/film end warning lamp, film transport indicator, recording level indication, aperture scale and over/under exposure warning marks.

- **Fast Filming Speed**

Speeds are 18 fps. for regular filming, 24 fps. for professional quality sound filming, and single frame with silent cartridges.

- **Wide Attachment Lens**

When the C-8 Wide Attachment Lens 43 is mounted with the wide angle macrocinematography setting, the lens functions as a super wide angle having a 5.9mm focal length. It is possible to film at this fixed focal length with a deep depth-of-field so that you can enjoy

filming without too much worry about the filming distance.

● **Other Functions**

- * Collapsible grip as the battery compartment.
- * Cue light that indicates filming for the subject's benefit.
- * Power zooming.
- * Remote control.
- * One power source for all circuits by 6 penlight batteries.
- * External power pack, for use especially in cold weather or during extensive filming.
- * Built-in collapsible rubber hood.
- * Dioptic adjustment.
- * EE lock for shooting against the light.

Specifications

Type: SLR type for Super 8 Sound and silent XL filming.

Size of Picture Frame: 5.8 X 4.2mm

Lens: f/1.4 9mm—45mm focal length, 5X zoom ratio.

Lens Construction: 13 elements in 11 groups, Spectra Coating; filter thread size: 43mm; lens cap size: 45mm; rubber hood: built-in.

Macrocinematography Mechanism: It can be switched to wide-angle or telephoto macrocinematography by the macro setting lever.

When the distance scale is set to ∞ , close-up shooting distance and field size are:

227mm, 74 X 102mm for wide-angle macrocinematography.

600mm, 44 X 61mm for telephoto macrocinematography.

Focusing Adjustment: Rotating front component.

Distance Scale: ft 4 5 10 30 ∞
m 1.2 1.5 2 3 5 10

Zooming: Power zooming by electric motor, besides manual zooming. Power zooming speed is about 8 seconds. (18 fps.)

Viewfinder: Single lens reflex viewfinder with split-image focusing screen.

Information: Recording level indication, aperture scale, over/under exposure warning marks, battery check/film end warning lamp and film transport indicator.

Dioptric Adjustment: Dioptrically adjustable from -4 to +2 dpt.; with lockable eyecup.

EE Mechanism: Automatic exposure mechanism coupled to ASA film speed and filming speed. Through-the-lens EE with CdS photocell.

Light Metering Range: ASA 250, f/1.4, 18 fps. to ASA 25, f/32, 24 fps.

Film Speed: Artificial light: ASA 40 160 250
Daylight: ASA 25 100 160

Film ASA Setting: Automatically set when cartridge is loaded.

Color Temperature Adjustment Filter:

Built-in. Automatic cancellation when daylight-type film cartridge is inserted. Manual removal is also possible by switch located on the outer camera body.

Manual Exposure Control: For manual exposure control, the aperture value can be fixed with the EE lock lever.

Shutter Release Mechanism: Electromagnetic release system; remote control is also possible.

Filming Speeds: 18 and 24 fps. (with both silent and sound cartridges), besides single frame (for silent cartridge only).

Angle of Shutter Opening: 220°

Drive System: High-performance electric micromotor for film drive and power zooming.

Main Switch: Positions for "OFF", "R" (Running), "RL" (Running Lock) and "1" (Single frame shooting). A red mark confirms that power is on.

Power Source: The power source that is

used for the film drive system, power zooming, exposure metering and recording, consists of six 1.5V penlight batteries which are loaded into the grip.

Battery Check: A LED lamp lights in the viewfinder to confirm battery power when the battery check button is pressed.

Battery Life: Under normal temperature conditions, batteries are serviceable for more than 10 cartridges, or one cartridge or more for single frame shooting.

Footage Counter: Counts exposed film footage and automatically returns to S upon cartridge removing.

Cue Light: A red LED lamp lights on the lower right front of the camera while filming.

Film End Warning: The film end warning lamp lights in the viewfinder about 2 ft. before the end of film.

Sound Recording System: Magnetic stripe recording with Super 8 sound cart-

ridge. (continuous film transport via capstan)

Capstan Motor: With AC tacho generator

Recording Level: Automatic Level Control (ALC), Two settings, Auto/Low level.

Tone Select Switch: Two settings, Soft/Clear.

Sound Fading: Possible with Audio Level Dial.

Input Monitor: By the earphone and the recording level indication.

Microphone Input: Impedance about $3k\Omega$, $3.5\text{mm}\phi$ mini jack, Minimum input sensitivity -80 dB ($0\text{ dB} = 1\text{V}$)

Microphone: Impedance 500Ω (Dynamic Microphone), sensitivity -78 dB ($0\text{ dB} = 1\text{V}/\mu\text{ bar } 1\text{ kHz}$)

Aux. Input: Impedance more than $100k\Omega$, $3.5\text{mm}\phi$ mini jack, Minimum input sensitivity -20 dB ($0\text{ dB} = 1\text{V}$)

Earphone Output: Impedance 8Ω

Remote Control: With remote control switch or microphone remote switch ($2.5\text{mm}\phi$)

Film Compartment: Accepts sound and silent cartridges. Opened by film com-

partment opening knob.

Grip: Collapsible; serves as battery compartment.

Accessory Shoe: For attaching the Boom Microphone BM70.

External Power: 9V D.C. with External Power Pack.

Dimensions and Weight: $210 \times 136 \times 64\text{mm}$ ($8\text{-}1/4'' \times 5\text{-}3/8'' \times 2\text{-}1/2''$) (less grip, hood and eyecup); $1,495\text{g}$ (3 lbs. 4 ozs.) (including batteries)

Accessories: Included; Soft Case, 45mm Lens Cap, Dynamic Microphone DM30R (with windscreen, stand and clip), Earphone E, Remote Switch 60, Finder Cover, Rubber Mat.

Optional; Boom Microphone BM70, Boom Microphone BM50, Electret Condenser Microphone CM100, 43mm Filters, C-8 Wide Attachment Lens 43, Self-timer E, Interval Timer E, Power Pack 9V, Connecting Cord C300L, Microphone Extension Cord E450L, Wireless Controller LC-1, Headphone HP-M (not marketed in the United States and Canada).

Subject to change without notice.

Canon 514XL-S

Preparations Before Filming

● Unfold the grip.



● Load batteries.

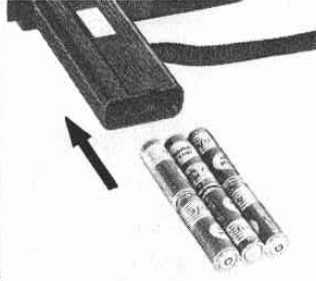

● Check battery charge. (when the main switch is on)

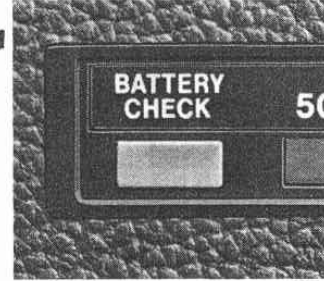

● Adjust eyepiece.

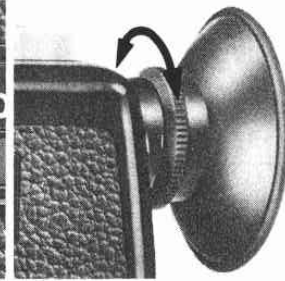

5 Connect the ear-
phone.

6 Set the Audio Level
Dial at "AUTO".

7 Set the Tone Select
Switch at "SOFT".

8 Set filming speed at
18.

9 Manual Zooming.

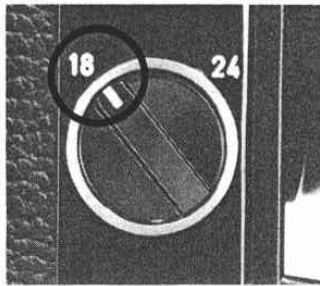
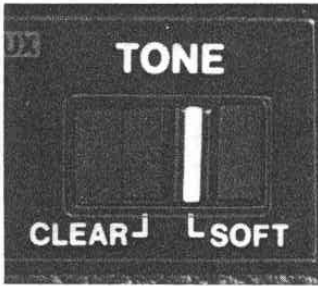
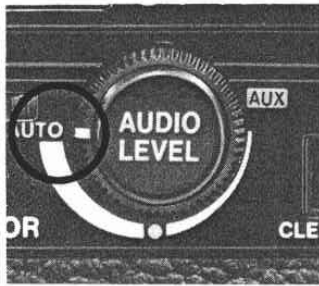
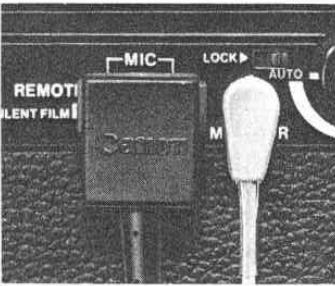

4 Set filming speed at
18.

5 Manual Zooming.

SOUND SHOOTING

- 1 Insert the sound cartridge.
- 2 Set the main switch at "R".
- 3 Check film advance.
- 4 Connect the microphone.

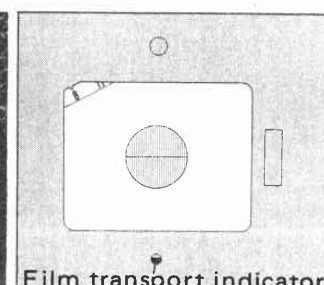
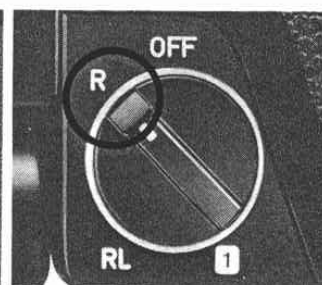
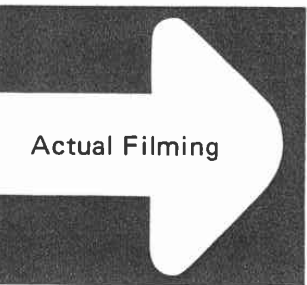

SILENT SHOOTING

- 1 Insert the silent cartridge.
- 2 Set the main switch at "R".
- 3 Check film advance.

10 Decide composition and focusing.

11 Confirm the exposure and recording level at the first step of the shutter release lever.

12 Set the microphone switch at "ON", and shoot at the second step of the shutter release lever. (Zoom as desired.)

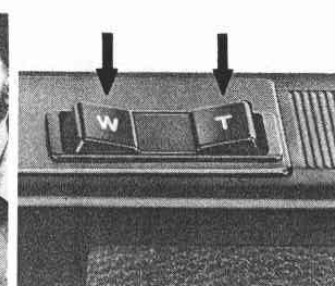
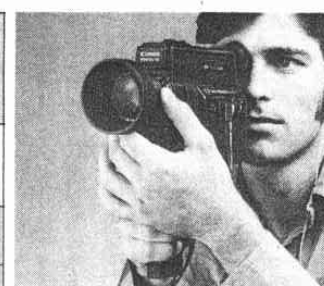
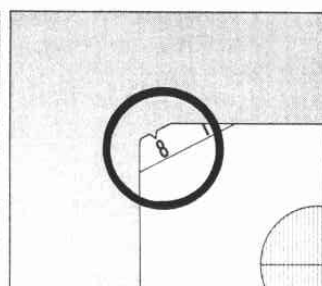
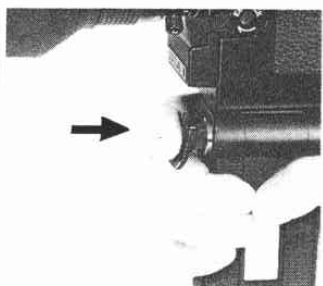

6 Decide composition and focusing.

7 Confirm the exposure at the first step of the shutter release lever.

8 Set the microphone switch at "ON", and shoot at the second step of the shutter release lever. (Zoom as desired.)

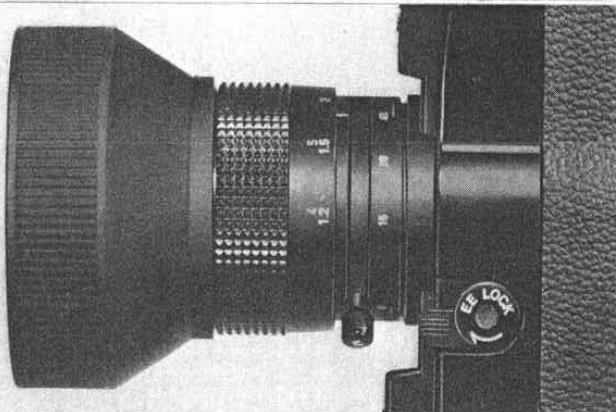

Before Use

The Canon 514XL-S is a movie camera for both sound and silent film making. It delivers exceptional performance for macro-cinematography and low-light XL shooting, plus beautifully natural sound quality for sound filming. There are many special features, such as automatic level control and sound fading, which you need to understand. We suggest you are fully acquainted with the camera's great potential.

How to Operate

- **Built-in Rubber Hood**

This is to avoid extraneous light while shooting. This is made of rubber and collapsible. To use it, simply pull it out.

- **Hand Grip and Strap**

The hand grip is collapsible and also functions as the battery compartment. When it is unfolded all the way, it clicks into position ready for use. Please be sure to loop the strap around your hand and grasp the grip for safety. It can be collapsed by pressing the grip locking lever and folding the grip up against the body.

- **Rubber Mat**

This is a rubber mat to protect your hand from the tripod socket and make holding the grip easier.

1 Battery Loading

As this camera will not operate without batteries, batteries must be loaded before checking the operation. Six penlight batteries loaded in the grip are all that are used for film drive, light metering and recording. First unfold the grip for loading the batteries. Insert the edge of a coin into the slot on the bottom part of the grip and rotate it to "OPEN". The cover of the battery compartment will come off. Load the batteries correctly according to the chart on the inside of the grip. Cover the compartment making sure of its direction and return the lock to the "CLOSE" position.

* Do not force past the "OPEN" or "CLOSE" position.

It cannot be locked if the cover is facing the wrong way. All penlight batteries can be used. However, be sure all the same brand of batteries are used. For photography in cold places, Alkaline batteries or Ni-Cd batteries are highly recommend-

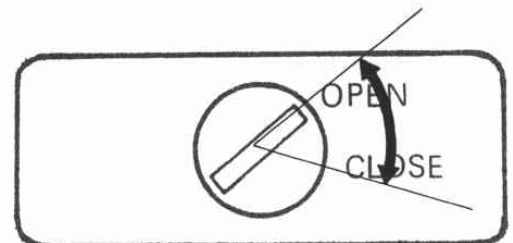
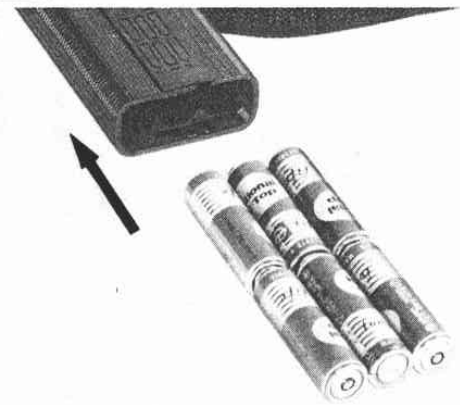
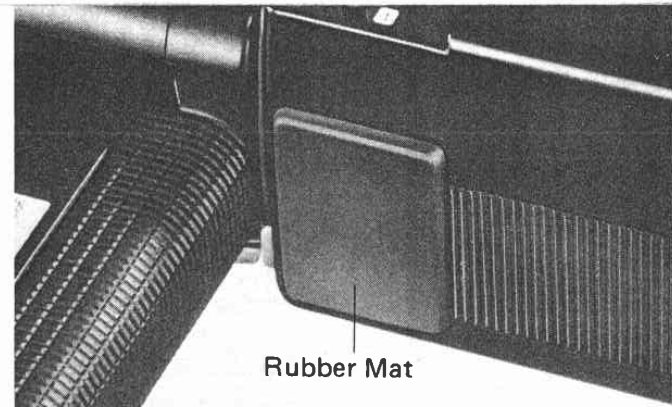

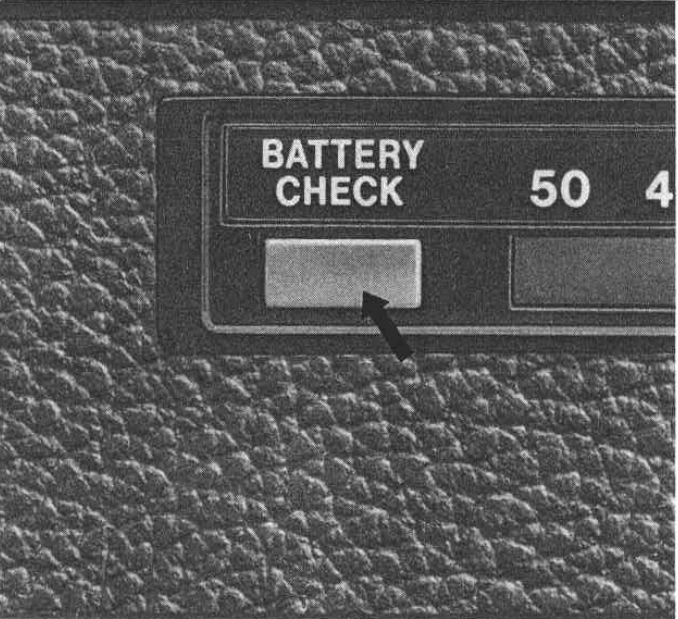

ed. Loading the batteries facing the wrong way, can be very dangerous as short-circuits caused by inverse current flows are possible. Unload the batteries if the camera is not being used for a long period of time in order to prevent possible damage to the camera by battery leakage.

● **Battery Life**

When new Manganese batteries (size AA) are used in normal temperatures:

- Regular shooting: more than 10 cartridges.
- Single frame shooting: more than one cartridge.

* It may vary a little according to the frequency of zooming or use of sound film.

● **Battery Check**

You cannot photograph correctly when batteries become weak. It is particularly necessary to check batteries when the camera is used in cold places, after it is not used for a long time, and when the batteries are changed. Set the main switch at "R", look into the viewfinder, and press the battery check button. If the red lamp on the right side of the viewfinder lights, it means there is enough power. If it doesn't light, replace the batteries with new ones.

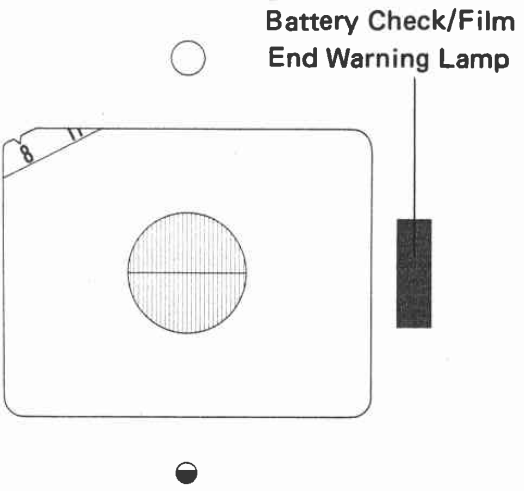

2 Main Switch

The switch has "OFF" in the middle, "R" and "RL" towards the left and 1 towards the right. It cannot move from 1 to "RL" position. "R" indicates the regular photography position. "RL" indicates running lock position and it locks the shutter release lever for continuous photography.

1 indicates the single frame shooting position for silent film cartridge. The meter always uses current at any position other than "OFF", so be sure to set it to "OFF" when the camera is not in use in order to avoid wasting the batteries. The red mark is a safety feature.

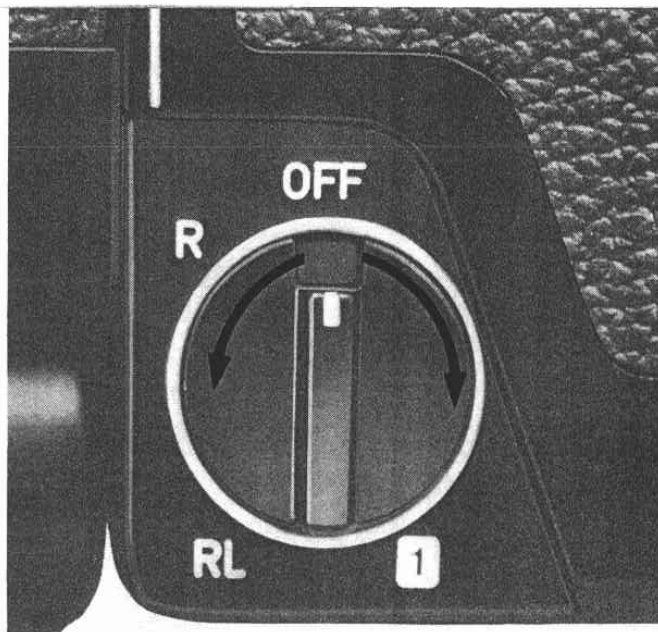

3 Dioptic Adjustment

If the viewfinder is not adjusted to the user's eyesight, blur and the misreading of information in the viewfinder can result. To prevent this, adjust the viewfinder before use. Set the distance scale of the lens to ∞ , turn the lock ring of the eyepiece to the left and look into the viewfinder, focusing toward the sky. Rotate the eyecup either to the right or to the left until you can see the rangefinder in the middle clearly and then lock the ring. The range of the eyesight compensation is from -4 to $+2$ diopters.

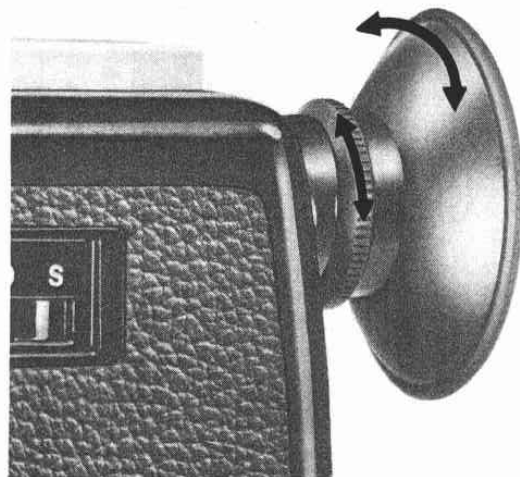

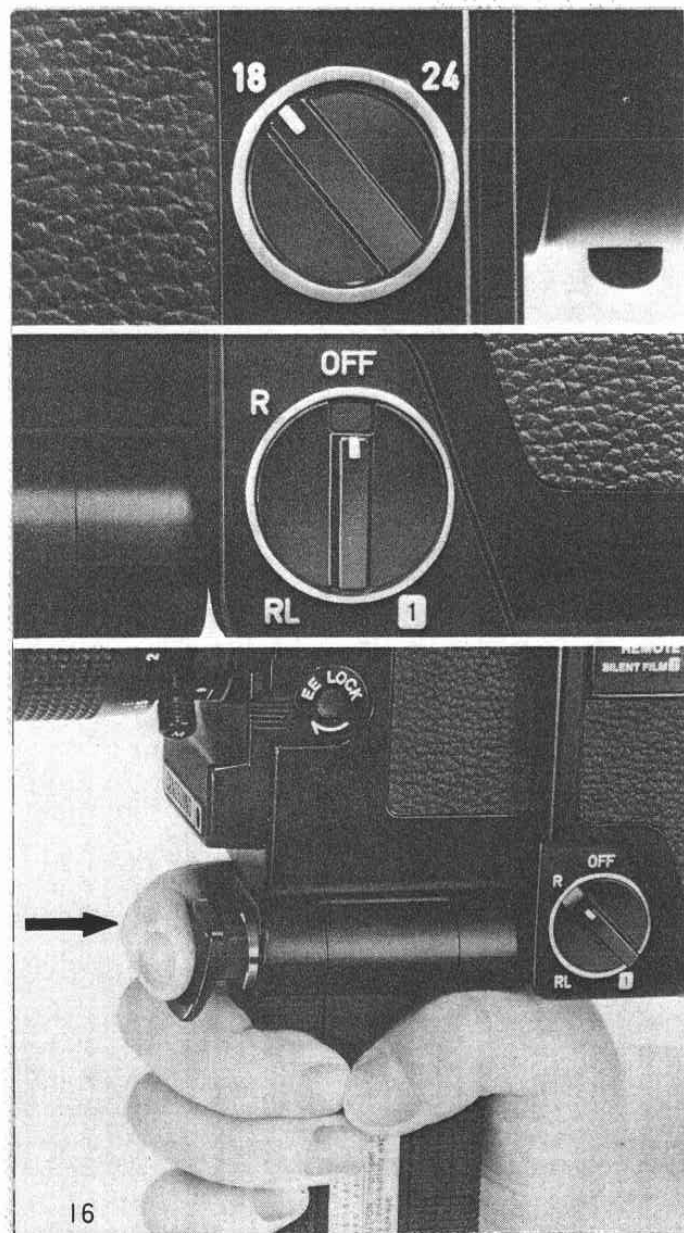

4 Setting the Filming Speed

There are three different filming speeds: 18 fps., 24 fps. and single frame for silent film. Both 18 fps. and 24 fps. are for sound movies, but generally for ordinary movies, the 18 fps. filming speed will attain good sound recording. The 24 fps. filming speed is used in order to achieve best sound and image quality. If filming speeds are mixed in one film, the pitch at projection is changed so this should be avoided. The filming speed can be set to 18 and 24 fps. by rotating the filming speed dial, and single frame shooting can be set by the main switch. The shutter speed for 18 fps. is about 1/30 sec, and for 24 fps. it is about 1/40 sec.

5 Shutter Release Lever

After setting the main switch to "R", depress the shutter release lever to start shooting. This shutter release lever has two steps. The first step is to meter the light and for sound monitoring. The second one is to start filming.

6 Viewfinder

The viewfinder contains all the information necessary for shooting, such as the split-image screen in the middle of the viewfinder, and the aperture scale, exposure warning marks in the upper left corner. In the viewfinder mat, there is the recording level indication at the top, the battery check/film end warning lamp on the right and the film transport indicator below.

7 Zooming

This camera can perform continuous zooming over its variable focal length of 9mm to 45mm by rotating the zooming lever. This is called "zooming" and it can be observed in the viewfinder. Zooming is used for the composing the picture image, or an effect of continuously changing magnification.

8 Power Zooming

During filming, the power zoom can be activated. Depressing "T" enlarges the subject and depressing "W" makes the subject smaller. Power zoom will stop when it reaches its limit at either extreme. The zooming time between "T" - "W" is about 8 seconds. The power zoom operates only when the shutter release lever is depressed.

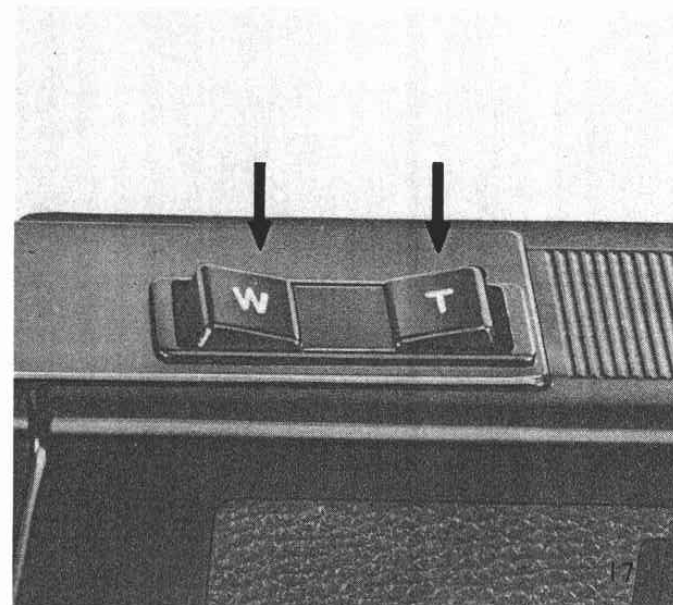
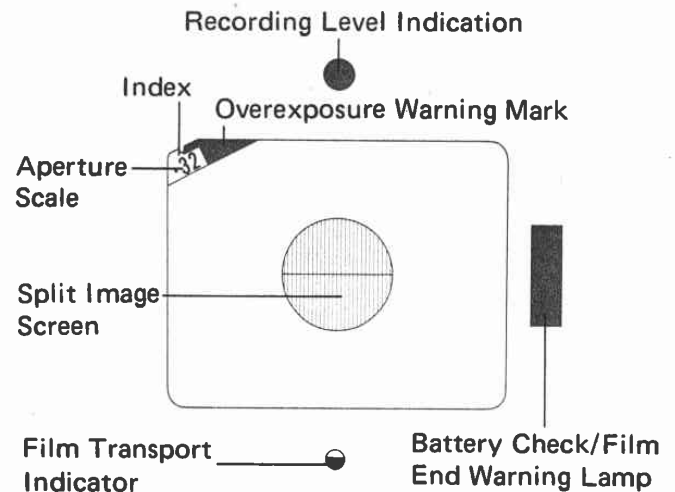



9 Manual Zooming

Although the power zooming is only possible at a constant zooming speed, if you would like to zoom at different rates of speed or for composing, you can use the manual zooming. Rotate the zooming lever to effect zooming. If this lever is pulled up, it will switch to macro-cinematography range so please be careful when using it.

10 Focus Adjustment

Rotate the focusing ring on the lens and check the focus inside the viewfinder to focus. When the upper and lower images match in the circle, it is focused correctly. Changing to telephoto after focusing at wide angle must be avoided because it will cause difficulty with the depth of the field.

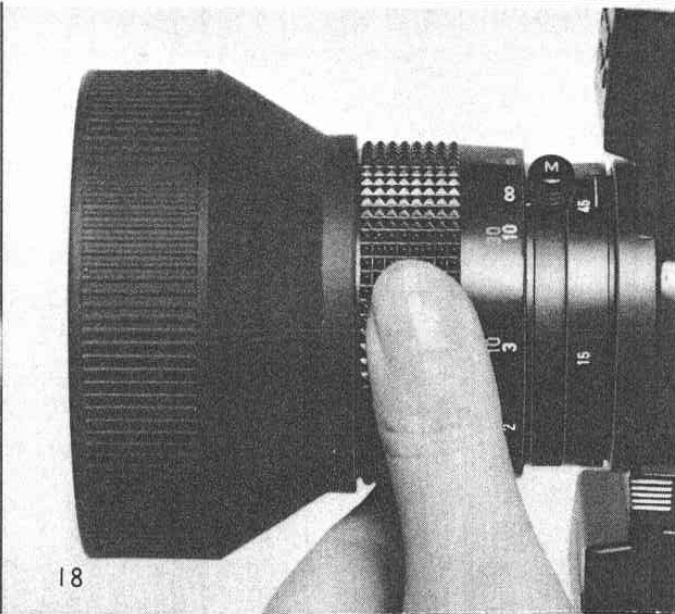

out of focus



in focus



11 CCA Filter

The super 8 camera is made generally so as to allow daylight photography with the use of Type A film (tungsten type). Therefore there is a CCA filter built-in that changes according to the film type within the camera. When shooting in daylight, the filter should be used, but when shooting indoors with artificial light, the filter should be removed. The color balance of the light is matched to the film by the filter.

- **Use of the CCA Filter Switch**

When shooting with Type A film under artificial light, press down the switch to the "💡" mark. For daylight shooting, push the switch up to the "☀️" mark. This operation is essential for natural color. With Type G film which is for both daylight and artificial light, and daylight type film, the filter is automatically removed in any case whichever way the film type switch is set.

- **CCA Filter Settings**

Film Type \ Light Source	Daylight	Artificial Light
	Type A (Tungsten Type)	☀️
Type G or Daylight Type	☀️ 💡 Both positions can be used.	

* Take care that you don't mistake the film type indicated on the package.

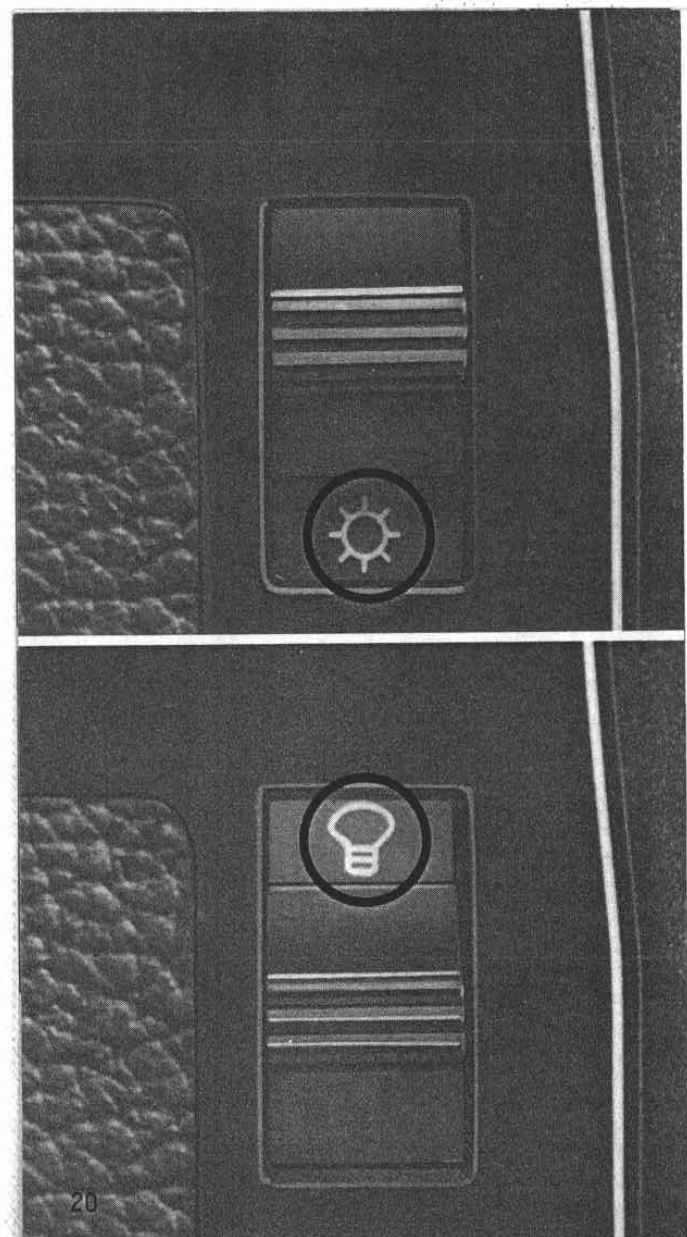

12 Film Loading

Pull out the film compartment opening knob in the direction of the arrow and the side cover slips downward. Hold the film cartridge with the label facing towards you and insert the aperture part first as the chart in the film compartment indicates, then press the cartridge in so it rests flat. Take care not to release the shutter release lever when inserting the sound cartridge because it can scratch the film. The silent cartridge has to be loaded above the recording head part. The film speed is also set automatically. When the main switch is at the "RL" position, sound cartridge can't be inserted or removed.

- * Be sure to set the main switch to "OFF" when you change films.
- * Sound monitor is not possible when the sound cartridge is not inserted in the film compartment. In this case, if you press the sound coupling switch in the film compartment, sound monitor is possible.

● Checking Film Advance

While looking through the viewfinder, press the shutter release lever. If the film transport indicator moves up and down, it is correct. If it doesn't, take out the cartridge and turn the spindle of the

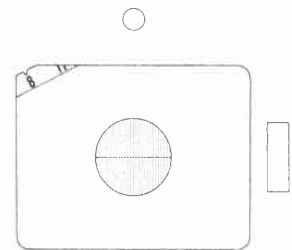
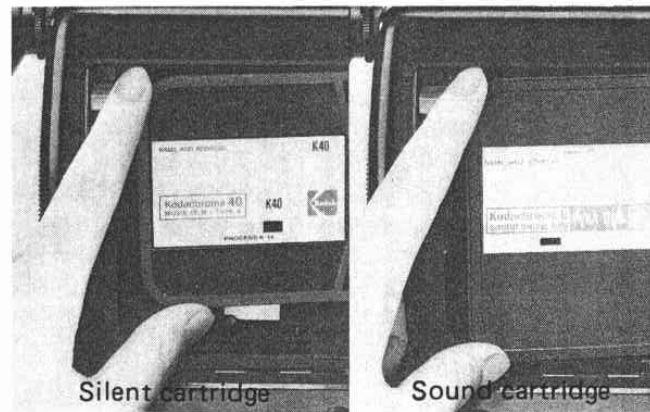
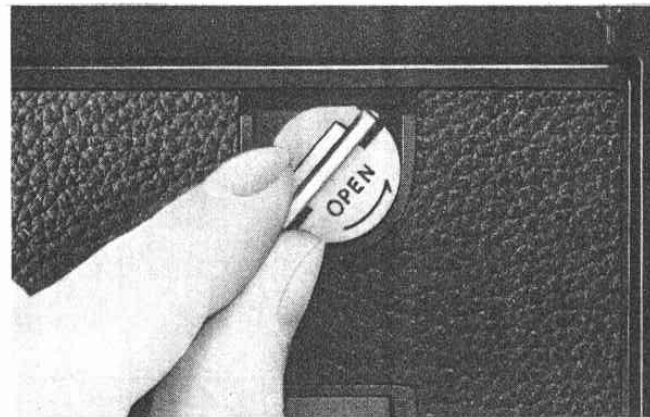

● — Film Transport Indicator

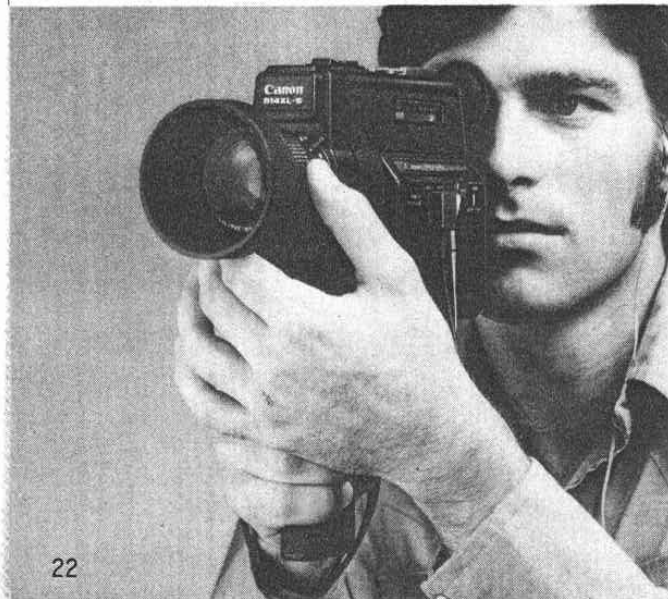
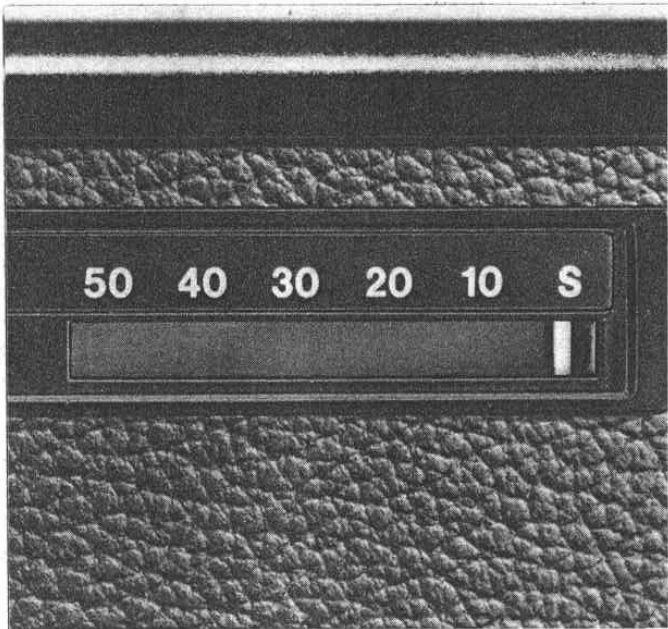

cartridge clockwise to remove any slack in the film. Then load it again.

- **Film Counter**

It couples with loading of the film cartridge and it functions during photography. It automatically returns to "S" when the cartridge is taken out.

13 How to Hold the Camera

Some ways of holding the camera will cause blurred movies or shooting out of focus, so make sure to hold the camera correctly. The fundamentals of holding the camera are to let your right hand go through the strap and to hold the grip with your index finger on the shutter release lever. Use the left hand for zooming or focusing on the upper part of camera and for holding the upper part of the camera body while shooting. Also, when holding the camera, press your right elbow firmly against your body to prevent blur. Keep your feet slightly apart. If you are panning, do so turning the upper body only from side to side, without moving from the hips down. The ideal, when possible, is to use a tripod and cable release in order to avoid blur.

* When using a tripod, choose a durable one which has soft rubber caps on the tips of tripod's legs.

14 Checking the Exposure

At the first step of the shutter release lever, if

any f/number is indicated at the upper left corner, it means the exposure is correct and you can further press the lever to continue shooting. When the light is incorrect, the aperture scale will point to either the over or under exposure warning mark at either end of the scale. When the subject is too dark and the f/stop is beyond f/1.4, a bright light source or high speed film use is needed. When shooting out-of-doors at the f/32 end and the red mark is indicated, use an ND Filter. Photography with correct exposure is possible until the red mark goes beyond the index. Generally for shooting outdoors in the daytime, the use of low-speed film (ASA 40) is advisable. For indoor shooting or night time shooting, high-speed XL film (ASA 160) is recommended. About six frames with a silent cartridge, and about thirty frames with a sound cartridge are wasted in changing the film cartridge. When shooting out-of-doors in daylight and the red mark is indicated, use a ND Filter 4 or 8. Do not use two filters together.

15 Cue Light

A LED cue light on the lower front of the camera indicates that the camera's drive is in operation so the subject will know when filming has begun.

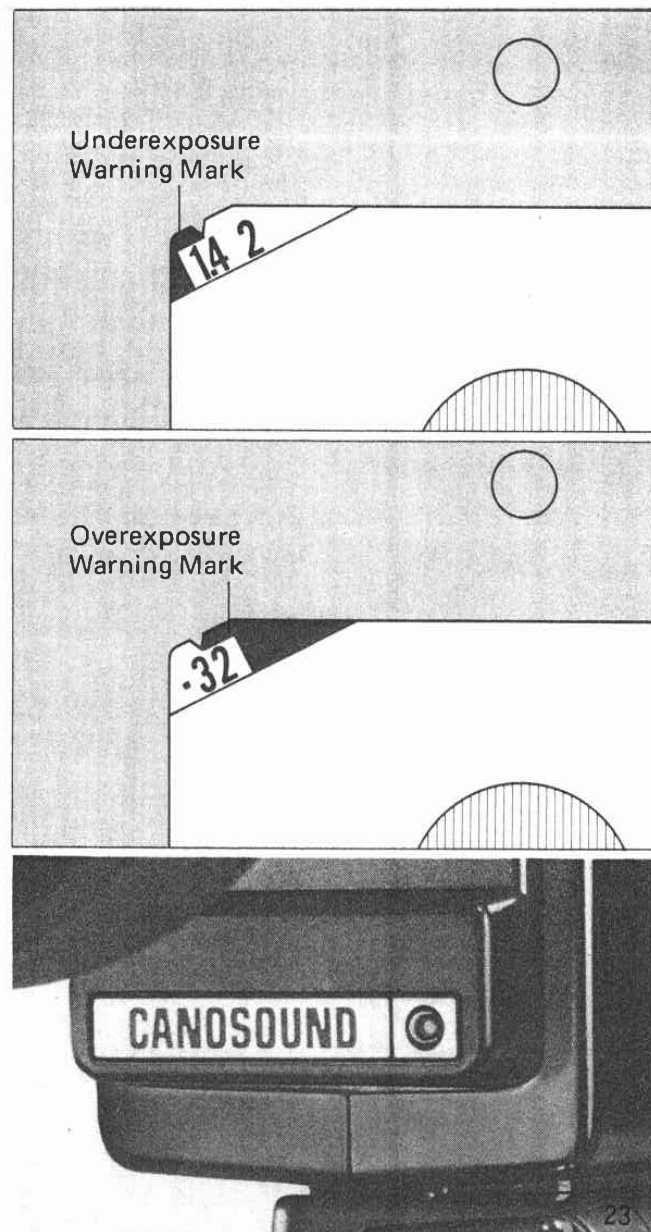

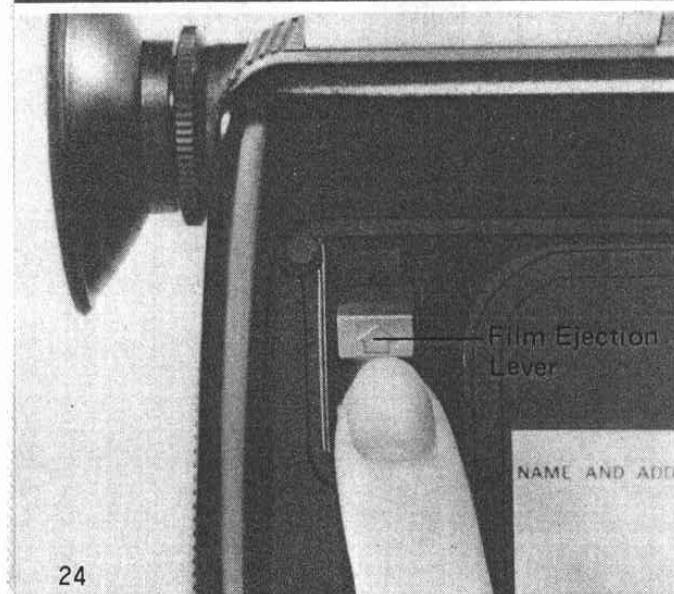
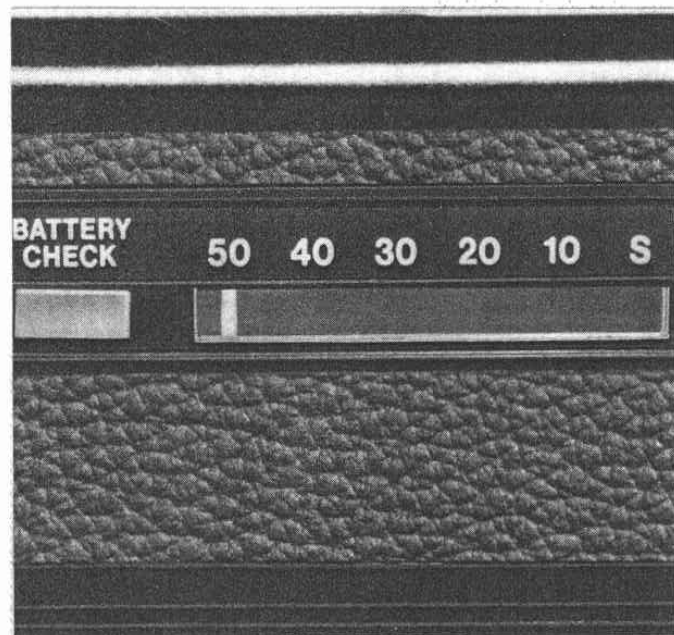

16 Film Transport and Film End Warning

While shooting, the film transport indicator moves up and down to indicate normal film transport, and when the film reaches about 2 ft before the end, the film end warning lamp on the right side of the viewfinder will light up. When the film ends, the film transport indicator ceases to move. Then, stop shooting and take out the film cartridge after making sure that the film counter indicates 50.

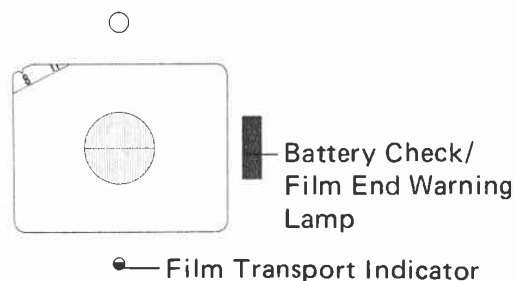

17 Removing the Film Cartridge

Set the main switch to "OFF" and open the side cover. As the Film Ejection Lever is moved in the direction of the arrow on the upper left of the film compartment, the film cartridge pops up to be removed. The exposed film has a cut at the perforated part and "EXPOSED" mark for distinguishing it from new film. The exposed film should be developed as soon as possible.

18 EE Lock Lever for Shooting Against Light

When you shoot against a strong light source, first meter the main subject or area to be photographed which you want to be most clearly or normally exposed, and set the EE lock lever to hold that reading. Then compose the picture and begin filming. While the lock lever is up, it locks the exposure, and it opens the aperture about one stop at a bright window, or 2 to 3 stops with a background of snow or sun. The EE lock lever is especially effective in high contrast situations, and can also be used effectively in panning where a difference in lighting conditions exist.

19 Macrocinematography

A macrocinematography mechanism at both wide angle and telephoto enables close-up shooting. Telephoto macrocinematography permits a greater shooting distance, so the exposure is more flexible and moving subjects are easier to catch. With close-up shooting it is possible to shoot small plants and insects, enlarging them in size to fill the picture frame. Wide angle macrocinematography is also suitable for title shooting. The following chart indicates the distance and field of view.

* For macro shooting, use an f/number greater than f/5.6.

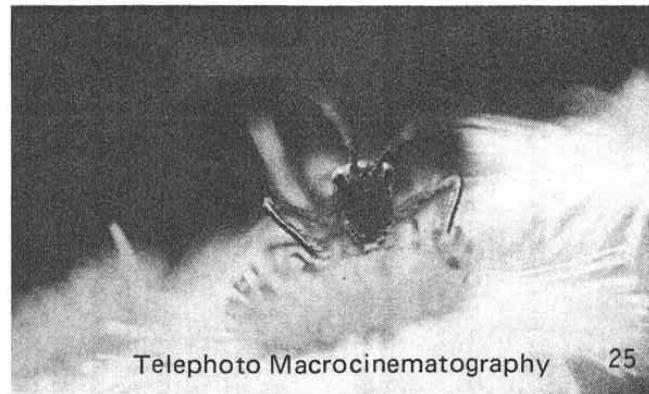
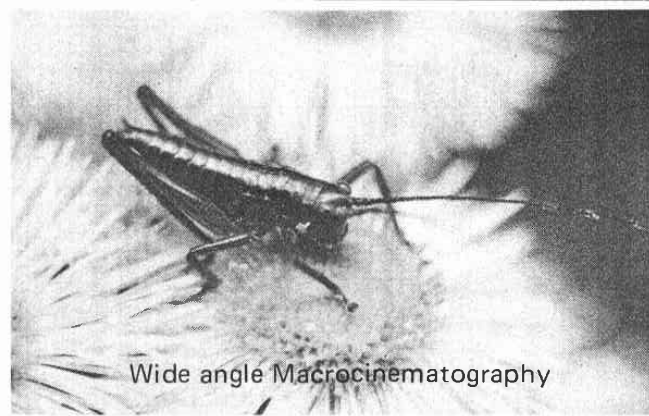
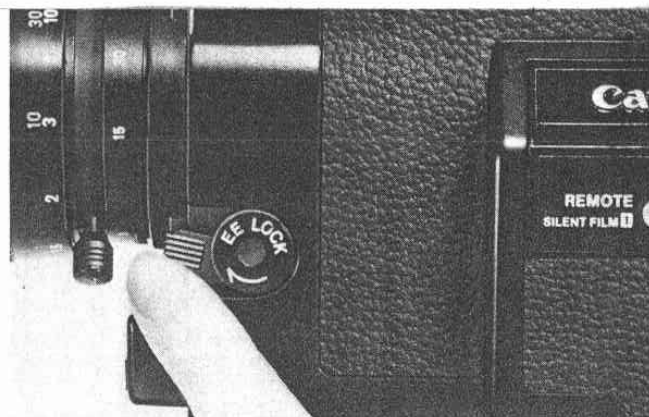

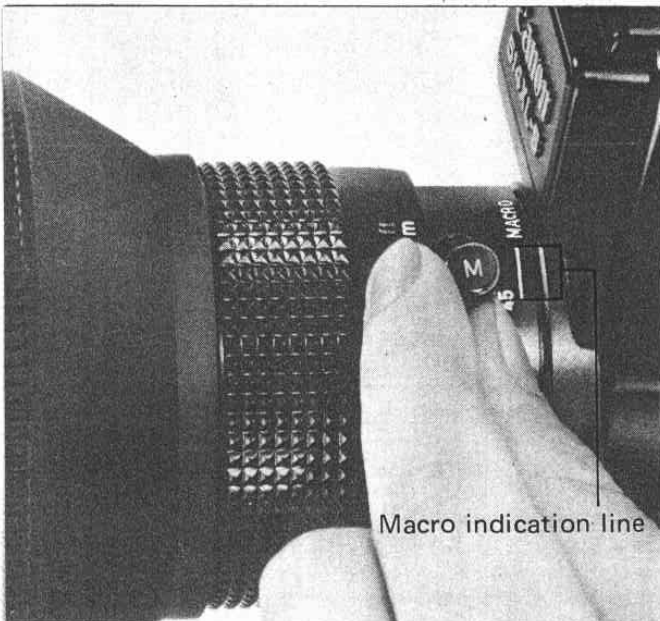

Macro indication line

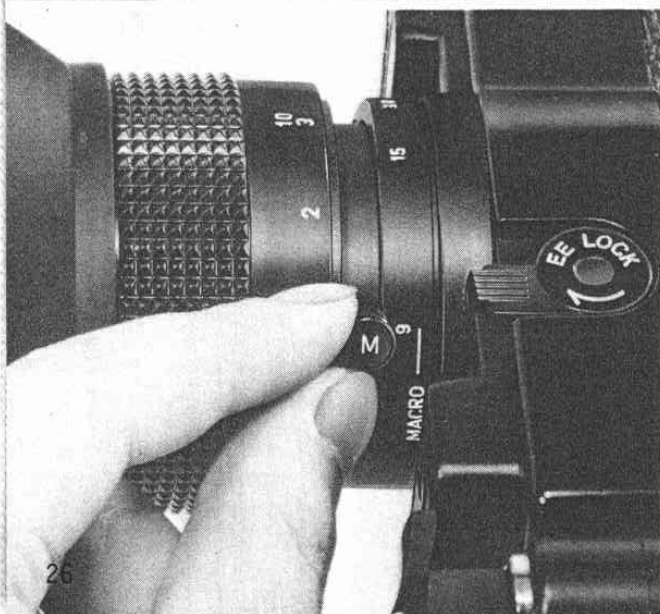

	Distance Scale of Lens	Photography distance from the Film Plane Indicator (approx.)	Field Size (approx.)
Wide angle Macro-Cinematography	∞	227mm	74×102mm
Telephoto Macro-Cinematography	∞	600mm	44×61mm

- **Setting for Macrocinematography**

Macrocinematography is set by lifting up the end of the macro-setting lever and rotating it to the macro position at either end of the zoom. With wide angle macrocinematography, the lever is fixed. To reset from wide angle macrocinematography lift up and turn the lever; from telephoto, just turn the lever.

- **Focusing in Macrocinematography**

Focusing after setting to macrocinematography is done by rotating the zooming lever. The shooting distance is continuous from macrocinematography to normal range. That is, if the focusing ring is set to 3m, it can focus from the minimum focusing distance for macro-cinematography to 3m by rotating the zooming lever. If the zooming lever is

rotated further, it functions as a zoom focusing at 3m. With telephoto macrocinematography power zooming can be used for shots of scenery.

20 Single Frame Shooting

Single frame EE shooting is possible when a silent cartridge is used.

1. Shooting is performed by the Remote Switch 60, an accessory, by plugging it into the remote control jack.
 2. Set the filming speed dial to 18. The correct exposure cannot be attained for single frame shooting at 24 fps.
 3. Single frame shooting is set by rotating the main switch to the right. Before matching the indication to **1**, the rotation requires more pressure, but you should go on and rotate it all the way to **1**. If it stops on the way, the film cannot be transported correctly.
 4. After confirming the exposure, press down the remote control to shoot. Everytime you press down the switch, a single frame is taken.
- * Single frame shooting is not possible using the sound film cartridge.
 - * After you finish filming, be sure to turn "OFF" the main switch first, before removing the Remote Switch 60 from the Remote Control

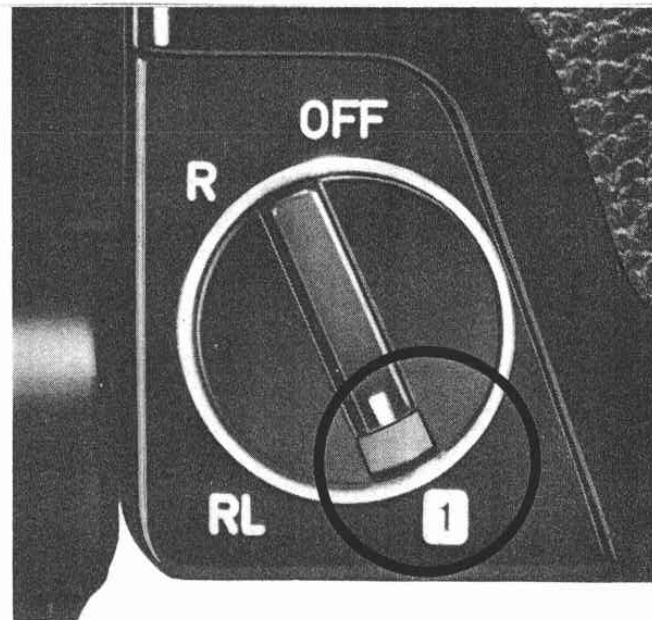

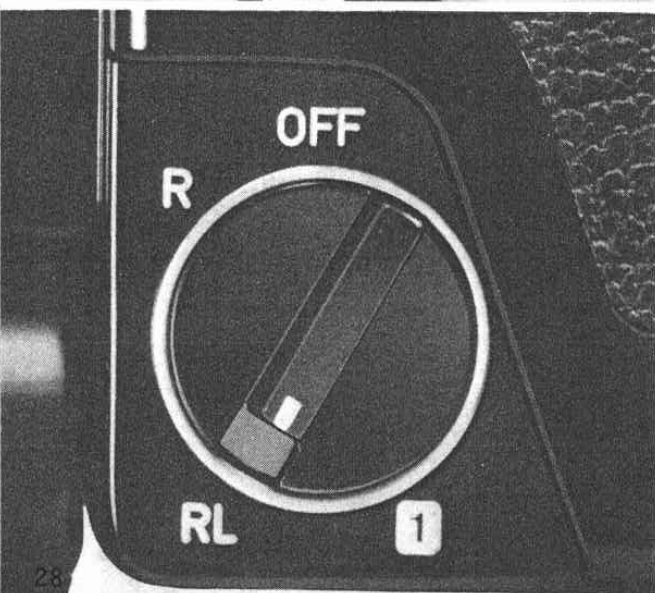
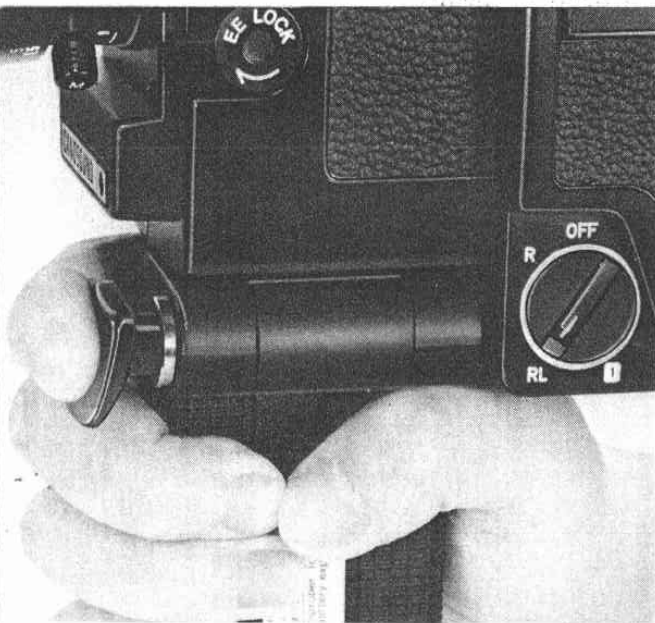

Jack. One frame will be wasted if you reverse the order.

- * Single frame shooting is used for the purpose of showing changes which take a long time in a much shorter period of time, or when doing animations. The shooting time and the number of frames have to be calculated beforehand. If there is a flower that blooms in one hour and you want to show it in 5 seconds, 18 frames times 5, that is 90, is the number of frames to be taken. Then the shooting time is divided by the number of frames 90, and each frame is taken at that interval. If the interval is less than 60 seconds, the Interval Timer E can be used instead of the Remote Switch.
- * Be careful not to use the microphone switch for single frame shooting. It can prevent correct film transport.

21 Running Lock

The running lock is for shooting continuously by locking the shutter release lever. Press the shutter lever to shoot, and then rotate the main switch to the left all the way to "RL". And it is locked at the release position when your finger is taken off the shutter release lever. Return the switch to "R" position to release the lock. This

running lock is used in remote control shooting with a Remote Switch 60 or with the microphone switch.

22 Remote Control Shooting

When the remote switch is used: Plug the Remote Switch 60 into the remote control jack. This cuts off the drive circuit, so press the shutter release lever and rotate the switch to "RL", releasing the lever. After this operation, as the button on the Remote Switch is pressed down, continuous shooting is performed while it is being pressed. Sliding the button to the arrow indication sets the running lock by remote control. To release the remote control, rotate the main switch to "R" first, and then unplug the Remote Switch. If the Remote Switch is unplugged first, the running lock is still on and the film continues to run. Don't try to insert or remove the sound cartridge while the main switch is at the "RL" position. There is a safety mechanism to prevent damage to the recording head of film. Film must be changed after setting the switch to off.

- **Finder Cover**

Please mount this finder cover before filming with remote control so that the light will not enter through the eyepiece and affect the picture image.

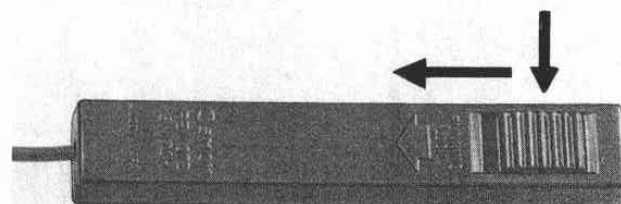
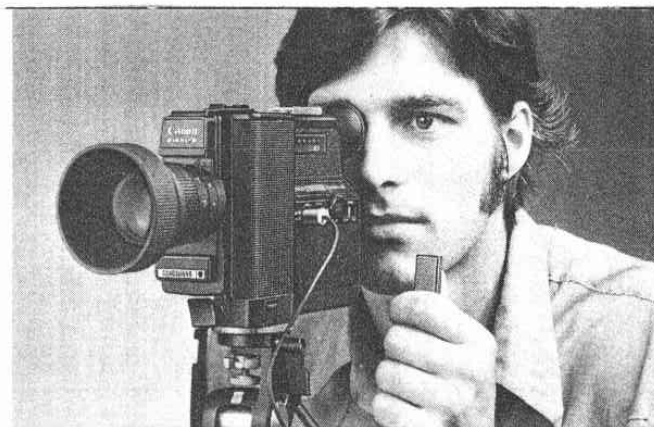



Sound Filming

Synchronized sound filming is performed with sound film loaded and the microphone connected to the camera. There are several points to be learned such as the operation of the microphone, tone, level control etc., for high-quality sound filming – with the Canon 514XL-S.

1 Attaching the Microphone

Switch off the main switch and connect the microphone to the microphone jack.

2 Audio Level Dial

This dial can be used for adjusting the audio level, for fading effects, (the audio level decreasing continuously to 0), and for switching the auxiliary input. Normal sound filming can be performed with "AUTO". By replacing the Dial Lock Button which is located on the left of the Audio Level Dial, it can be rotated from "AUTO" to "AUX". As the lock button is set according to the arrow the dial can be locked at two positions: Auto Setting Level (AUTO), and Low Level Setting (●). The following explains the characteristics of the audio level dial.

- **Automatic Level Control**

Automatic level control circuit is to control the

audio level automatically for the proper recording. There are two levels that can be set for different purposes.

Auto Level Setting: For normal recording.

Low Level Setting: For recording high volume sounds without distortion (e.g. the sound of jet planes or trains) or use of the mike near the subject's mouth with loud background.

- **Fading**

Replace the Lock Button and rotate the Audio Level Dial counterclockwise. The volume is continuously controlled from high level to 0, so it will permit fading out. As the dial is rotated clockwise, the volume level is increased to the standard level, so it will permit fading in. You should accomplish complete fade-in or fade-out in about 4 seconds for best result.

* It is advisable not to set the dial except in the two positions during filming since it cannot be locked.

- **Auxiliary Input**

Please refer to page 36 for the auxiliary input circuit which is the third feature of this dial.

3 Tone Select Switch

This switch is used for recording subject sound effectively or diminishing noise. For recording ordinary sound, it can be set to "SOFT".



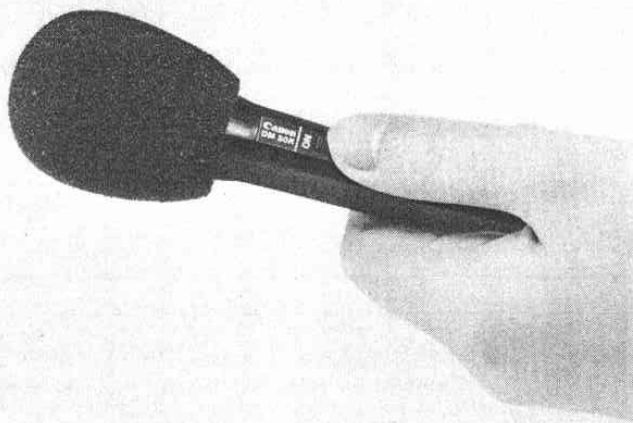

SOFT: The frequency characteristic of recording is normal. This setting is suitable for the subject's recording—music, drum, bell, including low-frequencies, and for quiet places with little reflected sound.

CLEAR: This eliminates low frequencies. It is suitable for recording where there is background noise or when people are speaking close to the microphone, or for outdoor recording when it is windy or noisy.

4 Microphone Positioning

The position of the microphone has to be decided according to the position of subjects. It has to be at least 1m away from the camera body in order to avoid the sound of the film drive. When it is windy, the microphone should be used with the windscreen. Set the microphone as close as possible to the subject, use a microphone stand or improvise. For example, it is possible to hang it in a tree, or have an assistant hold it.

- **Microphone Switch:**

Switch "ON" the microphone after setting it in position.

5 Sound Monitor

There are two sound monitors, the earphone and the recording level indication in the viewfinder.

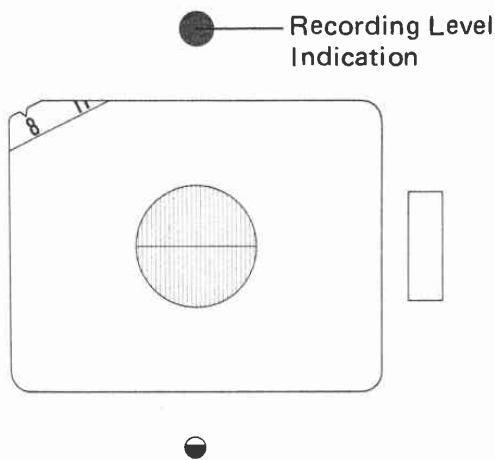

Both are activated at the first step of the shutter release so monitoring is possible without filming.

Earphone Monitor: After installing the earphone in its jack, pull the shutter release lever to the first step and listen. Adjust the microphone position for best sound with the least possible noise.

Recording Level Indication: The recording level in the viewfinder should vary in intensity, with changes in incoming sound. If it glows continuously, the sound input is too loud. Set the Audio Level Dial to the low level setting and lock it. Be sure to monitor through the earphone in noisy background. In loud surroundings the earphone monitor may not be audible. Then, rely on the visual recording level monitor.

6 Shooting

The shooting is performed at the second step of the shutter release lever. Direct sound recording is perfectly synchronized. It is important to decide the shooting time according to the subject recorded. Essential sounds especially, such as a conversations, explanations or announcements must be recorded longer since they cannot be cut in the middle.



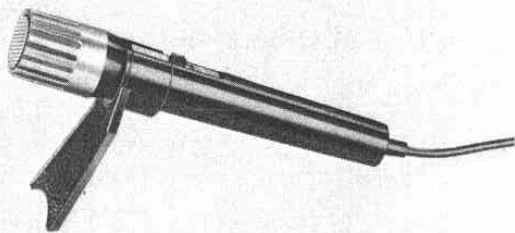

Windscreen



Dynamic Microphone DM 30R

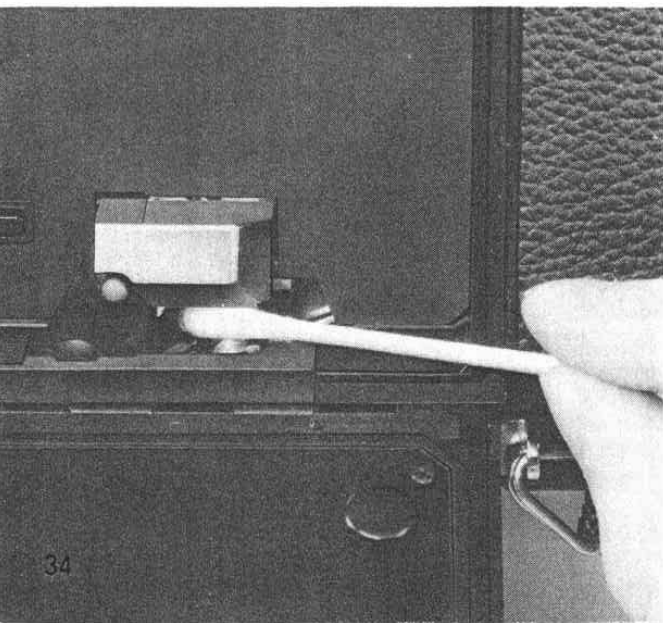

● Precautions

- * If the microphone is hit, a harsh noise is recorded.
- * When you require hand-held shooting, use the Canon Boom Microphone BM70.
- * Sound is recorded 18 frames ahead of the corresponding picture frame, which means the last 18 frames of one cut contains the sound of the beginning of the next cut. It is advisable to shoot one or two seconds longer than necessary for editing. Be sure to use an editing machine with a sound head so that you don't cut necessary sound portions of the film.
- * The Canon Sound Projector is highly recommended for editing and re-recording of the film. It can record background music or narration along with projection, as well as recording sound-on-sound.

7 Cleaning the Recording Head

Since film passes through the head, pinch roller and capstan, these parts become dirty and the picture image or sound quality can be affected. The recording head should be cleaned at least after every 5 cartridges. A head cleaning stick should be used for cleaning.

- * Please be careful not to touch other parts with the alcohol or the swab.





8 Auxiliary Input

When the sound is to be recorded directly from record, tape recorder, TV, or other sound systems, set the Audio Level Dial of the camera to "AUX". The Connecting Cord C300L is used to connect the auxiliary input to the recording jack (REC), line out or earphone jack of the sound system. The volume level is controlled by an ALC circuit. Switch on the sound source first, and then please make sure to check the recording level with the earphone by pressing the shutter release lever at the first step. If the sound is too low or distorted, adjust the audio controls for the proper setting. (Please refer to the instruction of the sound system.)

- * If the Tone Select Switch is set at "CLEAR", it has no effect at the AUX input.
- * If another cord is used, recording may not take place. You can confirm recording by the earphone.

9 TV Filming

This camera can also film image from TV effectively. Set to 18 fps, and with Type A film set to "☀" as in daylight shooting. This film will have a blue tone so either adjust the T.V.'s picture tube to a reddish tone or use a CCA filter. Be careful to avoid other sources of light or window reflections.

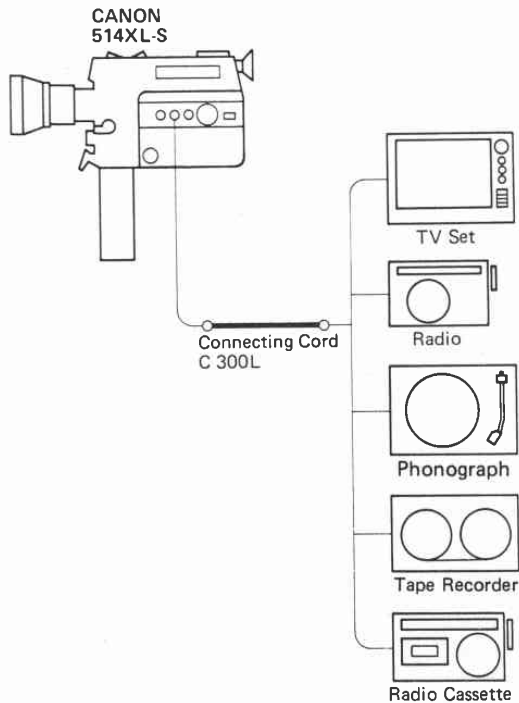

10 Remote Control with the Microphone Switch

The switch on the microphone enables sound filming by remote control. Switch the microphone "OFF", connect it to the camera and set the shutter release lever of the camera to "RL" position. When the microphone is switched "ON", sound filming begins. If the earphone is connected then, you can monitor the sound with the microphone switch at "OFF"

- * For sound filming controlled by the remote control with the microphone switch, determine the composition and insert the finder cover before filming.
- * The photographer himself can be in the film. If the cord of the microphone is not long enough, use the Microphone Extension Cord E450L.
- * You can confirm filming by checking the cue light.
- * Switch on quietly to avoid click noise.

11 Disconnecting the Remote Control with the Microphone

After filming, release the running lock to prevent battery waste. Before disconnecting, first release the main switch from "RL" position. If the microphone is disconnected first, it will start the film transport and waste film.

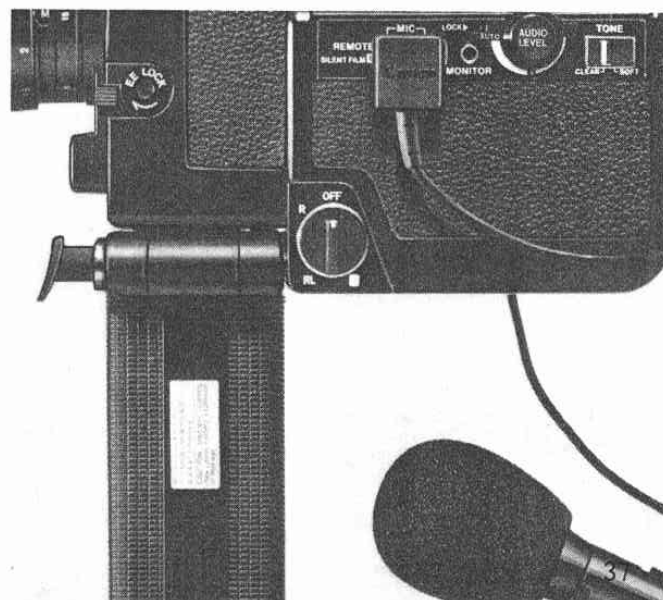
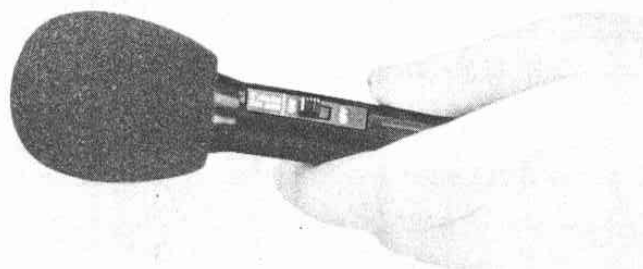
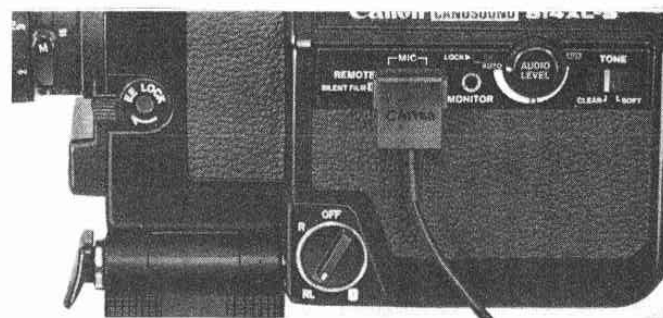

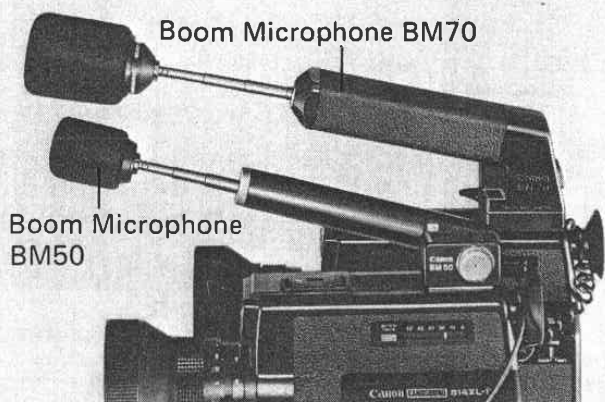

Boom Microphone BM70

Boom Microphone BM50

Accessories

- **Boom Microphone BM70 and BM50**

Use of two boom microphones are recommended when you film without an assistant or when you desire more freedom of movement. The BM70 can be rotated in eight 30° steps for a total of 240° . It can even be directed at sound source coming from other than where the camera is aimed. The BM50 was developed to be a counterpart to the BM70. Although lighter and more compact than the BM70, its direction cannot be changed. Both are unidirectional microphones.

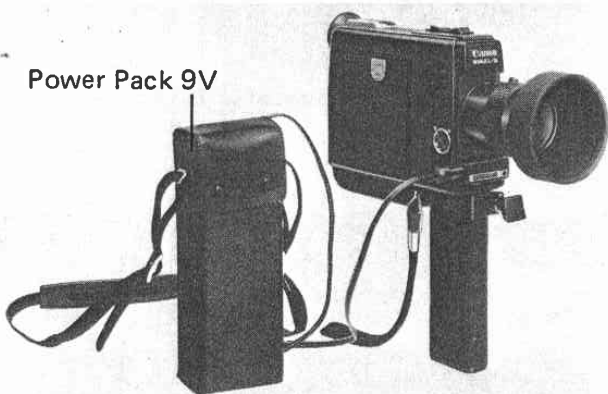

Power Pack 9V

- **Power Pack 9V**

This pack is provided for connection to an external power source (D.C. 9V) of 6 Size "C" batteries. This is for filming in cold conditions or should batteries fail.



- **C-8 Wide Attachment Lens 43**

This is an attachment lens for super wide-angle shooting. By only adjusting the macro setting lever to the macro position, you can easily perform super wide-angle shooting with the fixed focal length of 5.9mm.

- **Lighting Adaptor LA-1**

This accessory is used to attach the Movie Light to Canon 8mm sound movie cameras. Although this adaptor is attached to the accessory shoe on the camera body, a Boom Microphone, as well as the Movie Light, can still be attached.

*Do not attach the Movie Light directly onto the camera's accessory shoe.

- **Headphone HP-M**

This set of headphones can be used for both Canon 8mm sound movie cameras and the Sound Projector PS-1000 to monitor recording and playback. Since it is a low impedance type, it cannot be used with a middle or high impedance type camera or projector.

- **Wireless Controller LC-1**

Wireless Controller LC-1 is a remote control shooting device using infrared rays to control camera from distance without cord connections.

- **Others**

To expand your photographic horizons, a whole assortment of accessories is available for the 514XL-S. There are also the Microphone Extension Cord E450L, Connecting Cord C300L, Self-timer E, Interval Timer E, Remote Switch 60 and a complete line of filters for special image effects.

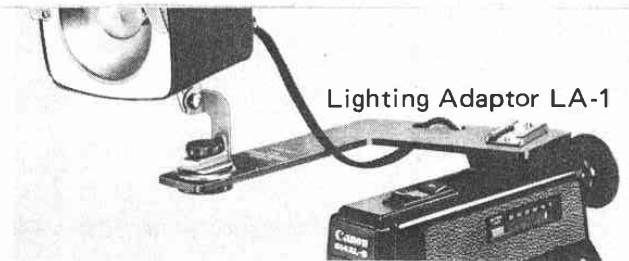

Lighting Adaptor LA-1



Headphone HP-M

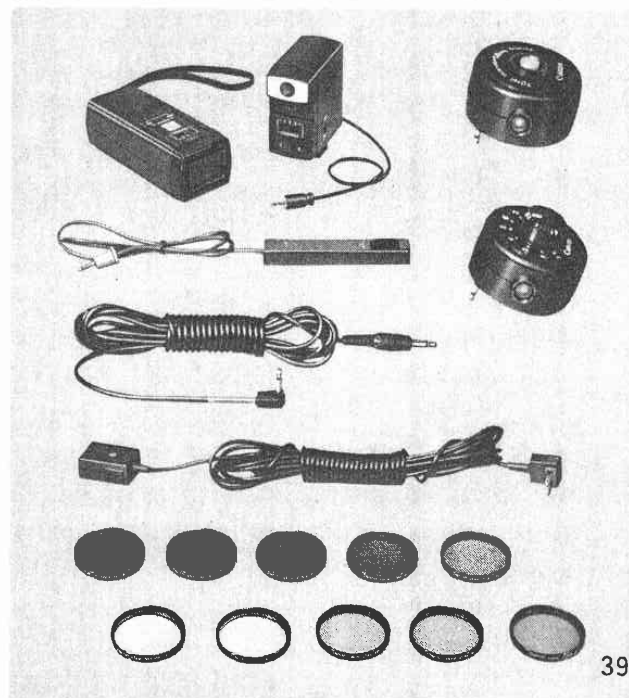

- **Cleaning and Storage of Camera**

However fine a camera is, it cannot function fully if it is not correctly taken care of. So be sure to clean the camera. It is advisable to use a blower brush, cleaner, lens tissue and silicon cloth.

- **Cleaning**

Dust can easily accumulate in the film gate and make the film dirty. If you get fingerprints on the lens, first blow the dust off with a blower brush and then wipe it lightly with clean, soft cloth. When you use the camera at a beach, please wipe it well because salt water is very bad for the lens.

- **Storage**

First unload the batteries and then store the camera in a dry place free from dust. You should avoid drawers with camphor or naphthalene. Problems can arise if the camera is not used over long period of time. It is a good idea to periodically release the shutter without film. The lens can get moldy, so it has to be checked every once in a while. If it does get moldy, it should be taken to a service center.

- **When the Camera is not in used**

When not in use, be sure the camera is switched "OFF" in order to avoid wasting the batteries, after shooting or when the camera is kept in the case.

- **High Temperature**

Do not leave the camera in hot places such as the rear window or trunk of a car or on top of a radiator. Keep sound films away from anything magnetic.

- **Caution with the Head**

Please avoid touching the head with anything metallic.

- **If the Camera is dropped in the water**

If the camera is dropped in water it is not easily repairable, but should be taken immediately to a service center.

- **Cold Temperatures**

Batteries usually deteriorate faster in temperatures below 0°C. (Alkaline or Ni-Cd batteries are highly recommended) If you can, warm the outside of the camera, especially the external battery pack with your body heat. Weak batteries in low temperatures return to normal power at normal tem-

peratures, so do not discard them. Always remember to check batteries in low temperature conditions. When not in use, put the camera in its case or keep it warm under your coat.

- **Temperature Changes**

Moving the camera suddenly to places where the temperature is considerably different, for example, from a warm room to the cold outdoors, causes a clouding of the lens and viewfinder, making the camera inoperable for filming. It is important to let the camera get used to temperature changes gradually. It requires about 30 minutes for a temperature change of 10°C. One way is to keep it tightly wrapped in a plastic bag for a while before filming.

Canon Boom Microphone Case

1. Pull the strap of the camera's soft case through the loop on the boom microphone case.
2. Fasten the microphone case's two snaps onto the nearest two buttons on the bottom of the camera case.

Boom Microphone Case



Canon 514XL-S Sound System

